



Do-it-yourself printing for safety  
& facility identification

---

# About Brady

Once you have worked with BRADY, our name will stick with you, (just like our labels) because BRADY is one of the world's leading labelling and identification specialists.



## Innovative

At BRADY we continue to improve. We have many customers from all industries, and we strive to be ahead of their needs by continuing to invest in research for even more performant solutions. By developing more user-friendly and efficient concepts, we give our thousands of customers the best in the market.

## Strength

At BRADY, we believe our biggest strength is the wide range of identification and safety solutions we can offer our customers, whether it's labelling the smallest component or complete signage for an entire warehouse. We're also proud to offer many products and services - from printers, scanners and software to service contracts and on-site training - that compliment any identification job. And don't forget, our wide network of expert distributors can always offer you a tailor-made solution to meet your specific requirements.

## Trust

For hundred years, BRADY has been connected with quality, trust and stability. We demand the best for your products and services, because we know, better than anyone, the importance of good and reliable identification. Identification looks like a small detail, but every professional knows that this kind of detail is crucial to any business.

## Inform

We also have specialised dealers in your region, who can answer all your identification and labelling questions, specific to your activity. They will be happy to provide you with all kinds of options and solutions with no obligation.

Microsoft is a trademark of Microsoft Corporation, Bluetooth is a trademark of Bluetooth Sig, Inc., Android is a trademark of Google Inc.



Brady products are sold on the condition that the purchaser will test them in actual use and determine for himself/herself their suitability to his/her intended purpose. Brady warrants to the purchaser that Brady products are free from defects in material and workmanship but limits its obligation under this warranty to the replacement of the product which has been shown to Brady's satisfaction to have been defective at the time of its purchase. The warranty does not extend to any persons who have acquired the product from the purchaser. It is in lieu of any other warranty, including every warranty of sale-ability, marketability or suitability for the intended purpose, and is also in lieu of any other obligation or liability on the part of Brady. Under no circumstances will Brady be liable for losses, damage, costs or subsequent damage of whatever nature which may arise in connection with the use of, or inability to use, Brady's products.

# Do-it-yourself printing

## The Brady advantage

When it comes to identification, safety and compliance, there's a clear advantage to working with Brady. We put our customers first in everything we do.

Our goal is to give you an unrivalled customer experience. We are relentlessly committed to performance and excellence - in our products, services and people.

Our products and solutions perform in ways that others simply can't match. Our people perform in ways that regularly exceed your expectations, and our focus and discipline work toward solid, long-term performance for our customers.

In short, Brady is the company you trust when performance matters most.

Learn more about the Brady advantage at: [www.bradyeurope.com](http://www.bradyeurope.com)



**M710**  
LABEL PRINTER



**BradyPrinter i3300**  
INDUSTRIAL LABEL PRINTER



**BradyJet J2000**  
COLOUR LABEL PRINTER



**BradyJet J4000**  
COLOUR LABEL PRINTER



**BradyPrinter S3700**  
SIGN & LABEL PRINTER



**BradyPrinter S3100**  
SIGN & LABEL PRINTER



**BBP85**  
LABEL PRINTER

## Contents

### Introduction

- 6-7 Printer comparison guide
- 8 Safety and facility identification
- 9 The best printer for your application
- 10 Brady label materials are made to impress
- 11 The best label material for your application
- 12 Brady safety printers online

### M710 Label Printer

- 14-19 M710 label printer and materials
- 20 M710 ribbons
- 20 M710 at a glance

### i3300, S3100, S3700 printers

- 22-25 i3300, S3100, S3700 printers
- 26 Safety sliders consumable kit
- 26 CLP/GHS consumable kit
- 27 Pipe marking consumable kit
- 27 General safety consumable kit
- 28-39 i3300, S3100, S3700 printer materials
- 40 Print ribbons
- 41 i3300/S3100 at a glance
- 42 S3700 at a glance

### BBP85 Sign & Label Printer

- 44-50 BBP85 Sign & Label Printer
- 45 BLS laminating system and panels
- 45 Safety sliders consumable kit
- 46-50 BBP85 Sign & Label Printer materials
- 51 BBP85 print ribbons
- 52 BBP85 at a glance

### BradyJet J2000 and J4000 colour label printers

- 54-57 BradyJet J2000 Colour Label Printer and materials
- 57 BS5609 marine
- 57 Laminates for outdoor durability
- 58-59 BradyJet J4000 Colour Label Printer and materials
- 60 Laminates for outdoor durability
- 60 Full colour tags printable at location
- 60 BS5609 marine
- 61 Create full colour rigid signs with BradyJet
- 61 Brady Workstation Desktop Software

### Materials

- 62-63 Master material index

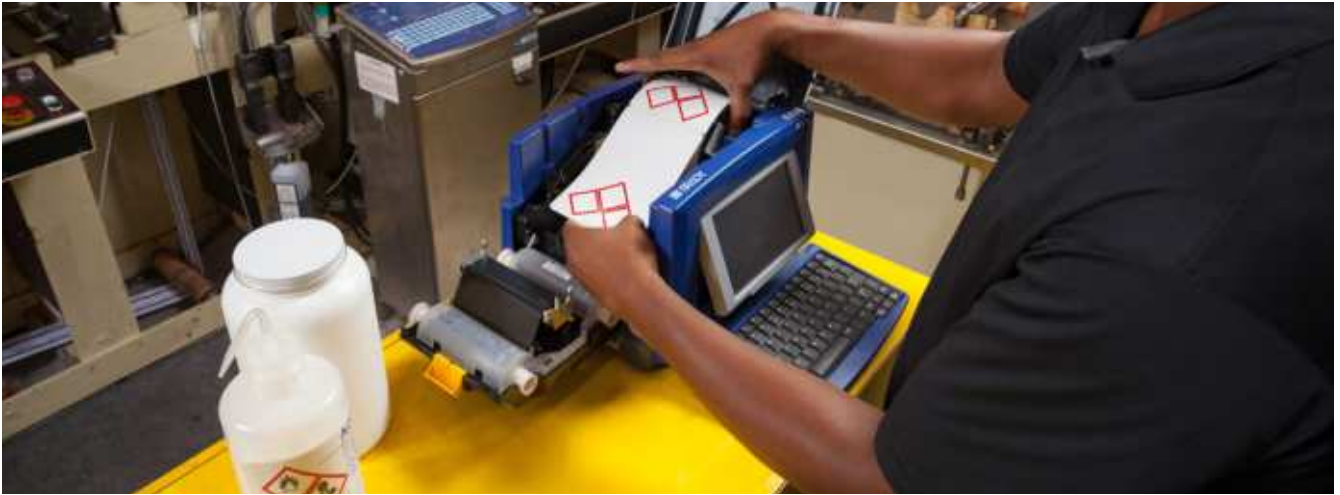


# Get the Brady printer advantage

You know that having the right identification in the right place keeps your facility safer, more efficient and more compliant. But take a look at the signs and labels in your facility:

- Are they handwritten?
- Do they fall off faster than expected?
- Do you have to wait for a label delivery before you get the identification up where you need it?
- Do you have to use an overly complicated printer with software that isn't quite compatible to create your sign or label?

If you answered yes to any of these questions, **you're ready for the Brady printer advantage.**



Whether you're looking for GHS labels, arc flash labels, pipe markers or other workplace visuals, Brady provides a complete line of on-demand printing solutions that are designed to save you time. **And unlike competitive offerings, every part of our printing solutions are designed to keep you running more efficiently. Here's how:**



### Faster printing

No need to send artwork to a vendor and wait up to seven days - create and print your label with your custom words, languages and logos when you need it.



### Less waste

The only complete solution on the market that includes labels, printers and software with print smart technology that work together to get from start to print in 30 seconds without any resizing, recalibrating or waste.

**PIPE** 4 in. label using a Brady printer

**PIPE** 4 in. label using a competitor printer



### Full facility applications

You get more than 300 material options that are designed to last in even the toughest environments and meet the highest quality and testing standards.

# Integrated into your workflow

When adding a piece of equipment to your facility, you want to make sure that it not only does the work you need, but also that it doesn't make a huge impact on your workflow. With Brady, you get a variety of printer options so you have the flexibility to get the tool that best fits your application needs and workflow.



## Stand-alone printers

**Ideal for multiple-user and network-free printing**

While you have the option to do your label creation on a computer, stand-alone printers have a built-in touchscreen, keyboard and intuitive design wizards so you can easily walk up, create and print without having to be connected to your network. These printers also provide multicolour printing options.



## Peripheral printers

**Ideal for single-user printing**

These compact printers require a desktop or laptop computer and easily fit into your tight areas so you can maximise your workspace to complete your single-colour printing tasks.



## Inkjet printers

**Ideal for full-colour printing**

Like the peripheral printers, our inkjet printers need a desktop or laptop computer to complete identification tasks, but boast the power of full-colour, high-resolution print quality so you can add custom images to your identification.



**Get the printer comparison guide**



# Printer comparison guide



	M710 Portable Label Printer	i3300 Industrial Label Printer	S3100 Sign & Label Printer	S3700 Sign & Label Printer
<b>Description</b>	More speed. Less mess. It's our fastest, most advanced portable printer yet. Print 76.2 mm per second. Auto-cut labels. Work all day on one charge. Use one device for 100's of applications, printing on the toughest materials around.	Get your ideal label printing scenario with the BradyPrinter i3300 Industrial Label printer – labels and ribbons that snap into place, no calibration and no wasted blank labels. Wi-Fi connectivity allows you to get data more easily from a variety of sources. Print smart technology allows the printer to print on the first label – even sleeves and small labels. Print on a full range of safety and facility label materials.	The easy-to-use BradyPrinter S3100 sign and Label printer is designed to meet a variety of your facility identification needs, helping you save time so you can get back to work. The built-in keyboard and touchscreen interface make label creation a breeze. Ideal for multi-user areas in your facility, anyone can simply walk up, create labels and print right on the spot.	Colour your way to an improved workplace with the S3700 Sign and Label Printer. With multicolour print and shape cutting capabilities, this printer creates impactful identification that fits your application and workspace needs.
<b>Printer Specifications</b>				
<b>Software compatibility</b>	Brady Workstation	Brady Workstation Windows based driver for 3rd party software use	Brady Workstation Windows based driver for 3rd party software use	Brady Workstation Express Labels Mobile App Windows based driver for 3rd party software use
<b>Colour capability</b>	Monocolour	Monocolour	Monocolour	Multicolour; Monocolour
<b>Connectivity options</b>	USB	Ethernet, USB, USB 2.0, Wi-Fi	Ethernet, USB	Bluetooth, Wi-Fi/Ethernet, USB
<b>Stand-alone printing (detached from PC)</b>	Stand-alone & Peripheral	Peripheral	Stand-alone & Peripheral	Mobile device connected, Stand-alone, Peripheral
<b>Cutter</b>	Single Hand Manual Actuate, Straight Cut, Between labels or at end of print job	Auto Cutter	Auto Cutter	XY Cutter and Auto Cutter
<b>Internal memory capacity</b>	200 MB	512 MB RAM, 195 MB IFFS Flash	256 MB	512 MB
<b>Max. label width (mm)</b>	50.80 mm	107.95 mm	107.95 mm	107.95 mm
<b>Max. print width (mm)</b>	50.80 mm	101.98 mm	101.98 mm	101.60 mm
<b>Max. print length (mm)</b>	1016.00	1524.00	1524.00	2530.00
<b>Print technology</b>	Thermal Transfer	Thermal Transfer	Thermal Transfer	Thermal Transfer
<b>Print resolution (dpi)</b>	300 dpi	300 dpi	300 dpi	300 dpi
<b>Max. print speed (mm/sec)</b>	38.00 mm/s	101.60 mm/s	76.00 mm/s	127.00 mm/s
<b>Width x height x depth (mm)</b>	241,30 x 332,70 x 116,80	228,60 x 241,30 x 304,80	304,80 x 241,30 x 260,35	482,60 x 279,40 x 361,95
<b>Weight (kg)</b>	2.46 kg	5.22 kg	9.07 kg	16.74 kg
<b>Keyboard type</b>	QWERTY, QWERTZ, AZERTY, CYRILLIC	None	Full size fold down keyboard QWERTY, AZERTY, QWERTZ, CYRILLIC	Full size fold down keyboard QWERTY, AZERTY, QWERTZ, CYRILLIC



	BBP85 Sign & Label Printer	BradyJet J2000 Colour Label Printer	BradyJet J4000 Colour Label Printer
<b>Description</b>	The BBP™85 Sign and Label Printer allows you to create upto 254.00 mm labels & signs in multiple colours. Its improved interface makes it easy to use for anyone.	The BradyJet J2000 Colour Label Printer is a practical and easy to use, full colour inkjet benchtop printer that can print reliable, high resolution signs, facility and laboratory sample labels. This printer comes with a free Brady WorkStation Basic Design Software Suite, enabling you to immediately start designing professional signs and labels.	The BradyJet J4000 Colour Label Printer is an industrial high quality printer. The wide format full colour inkjet label printer is very easy to use and prints reliable, high resolution signs, facility and laboratory sample labels in bright, vibrant colours to support workplace safety and efficiency. The printer includes the Brady Workstation Basic Software Suite for label design.
<b>Printer Specifications</b>			
<b>Software compatibility</b>	Brady Workstation, Windows based driver for 3rd party software use	Brady Workstation Windows based driver for 3rd party software use	Brady Workstation Windows based driver for 3rd party software use
<b>Colour capability</b>	Multicolour; Monocolour	Full Colour	Full colour
<b>Connectivity options</b>	Bluetooth, Ethernet (optional), USB, Wi-Fi	USB	USB, WiFi, Ethernet
<b>Stand-alone printing (detached from PC)</b>	Stand-alone & Peripheral	Peripheral	Peripheral
<b>Cutter</b>	Auto Cutter	Auto Cutter	Auto Cutter
<b>Internal memory capacity</b>	64 MB	No internal memory	No Internal memory available
<b>Max. label width (mm)</b>	254.00 mm	101.60 mm	203.20 mm
<b>Max. print width (mm)</b>	254.00	101.60 mm	203.20 mm
<b>Max. print length (mm)</b>	5090.16	609.60	609.60
<b>Print technology</b>	Thermal Transfer	Inkjet	Inkjet
<b>Print resolution (dpi)</b>	300	4800 dpi	4800 dpi
<b>Print speed (mm/sec)</b>	50.00 mm/s	63.50 mm/s	114.30 mm/s
<b>Width x height x depth (mm)</b>	500.00 x 310.00 x 500.00	264.16 x 180.34 x 388.62	438.15 x 231.14 x 438.15
<b>Weight (kg)</b>	24.04	3.20 kg	16 kg
<b>Keyboard type</b>	Full size fold down keyboard WERTY, AZERTY, QWERTZ, CYRILLIC	None	None



# Safety and facility identification



Multicolour safety signs



Pipe markers



Machine safety labels



GHS/CLP labels



Warehouse identification



Safety tags



Control panel labels




Labelling in food & bev. industry



Labelling in low light situations





	Stand-alone printers			Peripheral printer	Inkjet printers		
General and Industrial ID	M710	S3100	S3700	BBP85	i3300	J2000	J4000
 <b>Asset and component marking</b> Rating plate labels, push button labels, reflective tapes, etc. to be used on all kind of surfaces (smooth, rough, textured, low energy...) even in low light conditions, also on hazardous substances packaging...for text, symbols and barcode printing	★★	★★	★★	★	★★	★★	★★
<b>Safety and Facility ID</b>							
 <b>Safety panels</b> Pictograms, pictograms + text, wallcharts.	★	★★	★★	★★	★★	★★	★★
 <b>Visual equipment control</b> Create lean visual equipment controls like gauge labels, fluide level indicator levels, gradient rulers, and customise them to your personal needs.	★	★	★★	★	★	★	★
 <b>Energy source labelling</b> Create your facility's energy source identification for Lockout Tagout compliance.	★	★★	★★	★★	★★	★★	★★
 <b>Area and pathway marking</b> ToughStripe tapes, photoluminescent tapes, reflective tapes, signage etc. for floor labelling, exit and directional signage, fire alarms and extinguisher identification, for escape or evacuation routes indication...	★	★	★★	★	★	—	—
 <b>Lean warehousing identification</b> Tear resistant tags, tamper-resistant labels, rough surface labels, low surface energy and powder coated surface labels, repositionable labels, in and outdoor grade facility labels, general industrial labels, etc. to be used on all kind of surfaces (smooth, rough, textured, low energy...) for shelves labelling, bin location labelling, inventory labelling, logistics labelling...	★★	★★	★★	★★	★★	★★*	★★*
 <b>Pipe and valve marking</b> Tapes for pipes and valve marking. It stands up to grease, oil, etc. to be used on irregular, curved or rough surfaces for text and symbols printing	★	★	★★	★★	★	★★*	★★*
 <b>Food processing equipment marking</b> Toughwash labels: wash down resistant and metal detectable materials designed to withstand the harsh cleaning and sanitizing methods essential to the food and beverage industry.	★	★★	★★	—	★★	—	—
<b>Hazardous material labelling</b>							
 <b>Hazardous material labelling</b> Create your GHS/CLP labels using design templates that incorporate all the phrasing, pictograms and features you need for your hazardous material identification.	—	★★	★★	★	★★	★★	★★

— Not Recommended    ★ Acceptable    ★★ Preferred

\*For indoor use only.

# Brady label materials are made to impress



## Brady labels last the longest, period.

Brady labels stick and stay stuck, plain and simple. In fact, some last up to 10 years outdoors\*. You only need to make them once. And after you make them, they're there for good.

## Options. Lots of options.

We make labels for specific applications. That's why we have hundreds of label types and sizes to choose from. We want you to be 100% confident that you have the right label for your exact application.

## We set the bar high.

There's a reason why Brady materials lead the industry in durability and performance. It's because we design and manufacture the labels ourselves. We put our materials through rigorous, painstaking tests and trials – and nothing leaves our doors until it passes with flying colours. We set the standards high – because we know it's the only way our materials can exceed your expectations.

With label printing like this, the possibilities are endless.

\*Average expected outdoor life of product will depend on user definition of failure, climatic conditions, mounting techniques and material colour. The up to 8 to 10 year outdoor durability applies to the vinyl label stock only; ribbon durability will vary. A polyester overlaminate is recommended for harsh environments - long term exposure to wind and rain.

## Impressive material line up

Depending on the customer's needs, the printers can be used with over 400 material parts in 30 different materials designed for:

- Multicolour safety identification signs
- Pipe markers
- 5S labels and general purpose die cut labels
- Production line facility labels



# The best label material for your application

		Thermal Transfer Materials														Inkjet Materials												
		B-403	B-483	B-832	B-909	B-526	B-530	B-549	B-551	B-569	B-581	B-582	B-584	B-588	B-595	B-851	B-854	B-855	B-250	B-251	B-250*	B-251	B-2585	B-2595*	B-7125J	B-7569	B-7583	
<b>General and Industrial ID</b>																												
	<b>Panel Identification</b> • Panel and switch identification													★	★												★	★
	<b>Asset Management</b> • Office furniture • Tools & machines • Company cars	★				★									★						★			★		★		
	<b>Office Use</b> • Files • Door signs														★						★	★		★		★		
	<b>Events (badges, logo...)</b> • Exhibitions • Seminars • Advertising / communication agencies	★								★				★	★				★	★	★			★		★	★	
	<b>Services / Recreation</b> • Industrial contractors • Holiday centres, leisure centres • Theme parks									★					★						★			★				
<b>Safety and Facility ID</b>																												
	<b>Safety panels</b> • Pictograms • Pictograms + text • Wallcharts					★	★		★	★		★		★							★			★		★		
	<b>Evacuation Maps</b>					★	★		★												★			★		★		
	<b>Safety Procedures &amp; Machine Instructions</b> • Valve & switch identification • Emergency procedures • Lockout / Tagout • Schematics	★				★			★				★		★					★	★		★		★		★	
	<b>Pipe marking</b> • Individual pipe markers • Roll form pipe markers • Arrows									★					★						★			★		★		
	<b>Photoluminescent Signage</b> • Emergency escape routes • Assembly & Emergency point signs					★								★														
	<b>Maintenance</b> • Cleaning instructions • Repair instructions	★		★				★		★										★	★	★	★		★		★	
	<b>Logistic</b> • Warehouse & Stock • Bar codes			★			★			★					★					★	★	★	★		★			
	<b>Cut-Out Letters &amp; Signs</b>									★					★												★	
	<b>Tagout</b> • Safety tags								★						★						★							
	<b>Washdown labels</b> • For use in Food & Beverage Industry																	★	★									
	<b>Floormarking</b> • Durable, easy application and high visibility		★																									
<b>Laboratory Identification/Hazardous Material Labelling</b>																												
	<b>Laboratory Identification</b>	★																									★	★
	<b>Hazardous Substances ID</b>	★													★					★	★	★	★		★		★	
	<b>Transport</b> • Chemical substances • Directional signs • Informative signs									★					★												★ <sup>†</sup>	

\* For indoor use only. † BS5609 section 2 and 3 compliant

# Brady safety printers online

Surfing [www.bradyeurope.com](http://www.bradyeurope.com) is a simple, efficient and timesaving way to learn more about BRADY products and applications, industry developments, events, promotions, etc.

Visit [www.bradyeurope.com/safetyprinters](http://www.bradyeurope.com/safetyprinters) to find technical data sheets, update your Brady printers and software or quickly register Brady products!



For more information on featured printers visit: [www.youtube.com/BradyEurope](http://www.youtube.com/BradyEurope)



**M710** LABEL PRINTER

[Scan or click the QR-code](#)



**BradyPrinter S3700**

SIGN & LABEL PRINTER

[Scan or click the QR-code](#)



**BradyPrinter i3300** INDUSTRIAL LABEL PRINTER

[Scan or click the QR-code](#)



**BBP85**

[Scan or click the QR-code](#)



**BradyPrinter S3100**

SIGN & LABEL PRINTER

[Scan or click the QR-code](#)



**BradyJet J2000** COLOUR LABEL PRINTER

[Scan or click the QR-code](#)



**BradyJet J4000**

COLOUR LABEL PRINTER

[Scan or click the QR-code](#)



## See your printer of choice in action

Experience live how the printer works in the hands-on printer demo at your premises, or watch how it operates via a live feed.

Discuss with our specialist how the printer will support you in your specific context to choose the system that best suits your needs.

[www.bradyeurope.com/safetyprinters](http://www.bradyeurope.com/safetyprinters)



### Register your product

After registering your product you will have access to:

- Technical support
- Notification of updates
- Special offers and product announcements

[www.bradyeurope.com/registration](http://www.bradyeurope.com/registration)







## M710 Label Printer

- 14-15 M 710 Label Printer
- 16 B-595 high performance indoor/outdoor vinyl
- 17 B-584 reflective vinyl
- 17 B-582/B-526 Phosphorescent polyester tapes
- 17 B-483/B-634 ToughStripe area marking tape
- 17 B-854 and B-855 ToughWash series labels
- 18 B-581 repositionable vinyl
- 18 B-7593 EPREP labels – engraved plate replacement labels
- 18 B-569 High performance polyester
- 19 B-549 Cold temperature application material
- 19 B-530 security identification labels
- 19 B-423 and B-428 pre-printed labels
- 19 B-483A pre-printed labels
- 19 B-424 paper labels
- 19 B-509 Printable magnetic supply
- 20 M710 ribbons
- 20 M710 at a glance





## M710 LABEL PRINTER

**MORE SPEED. LESS MESS.**

Print on just about anything.

Take on more jobs, and get them done in record time with the all-new M710 Label Printer. Fast and flexible, it's your tool for seamless label creation from the shop to the field. Design and print with a mobile app, software or keyboard and colour touchscreen. Enjoy printing on the toughest materials around, plus extra durability from a Li-ION battery that lasts all day long. Better jobsite performance starts with the M710.



For videos and more information please visit: [www.bradyeurope.com/M710](http://www.bradyeurope.com/M710)

### M710 printer

Order Reference	Art. No.	Description
M710-QWERTY-EU	317810	M710 Label Printer QWERTY EU
M710-WB-QWERTY-EU	317811	M710 Label Printer QWERTY EU with Wifi and BT
M710-QWERTY-UK	317812	M710 Label Printer QWERTY UK
M710-WB-QWERTY-UK	317813	M710 Label Printer QWERTY UK with Wifi and BT
M710-AZERTY-EU	317814	M710 Label Printer AZERTY
M710-WB-AZERTY-EU	317815	M710 Label Printer AZERTY, Wifi, BT
M710-WB-QWERTZ	317816	M710 Label Printer QWERTZ with Wifi and BT
M710-WB-CYRILLIC	317817	M710 Label Printer Cyrillic with Wifi and BT
M710-US	317834	M710 Qwerty US Label Printer
M710-WB-US	317835	M710 Qwerty US Label Printer with Wifi and BT

This printer ships in a hard case holding a USB cable, a quick start guide, a product USB (with product info and Windows driver), a Li-ION Rechargeable Battery, an AC Adapter, a Brady Workstation Design Software, a Media Adapter, a roll of M7C-1000-595-WT and an

M7-R6000 ribbon.

Includes the Brady Workstation Basic Suite as standard - <http://workstation.bradyd.com/>

### M710 accessories

Order Reference	Art. No.	Description
M71-CLEAN	114886	Cleaning Kit
M710-HC	175664	Hard Case M710 Label Printer
M71-ADAPT-BK	147998	Media Adaptor for high-end portable printer
BMP-SC-3	150619	Protective softbag for portable printers
M-LION-BATTERY	175673	Rechargeable Lithium-ion Battery for M610/M710 printer
M-NIMH-BATTERY	175674	Rechargeable NiMH Battery for M610/M710 printers
USB-C-A-CABLE	175665	USB-C to USB Type A Cord

### GET MORE DONE WITH:



**LIGHTNING-FAST PRINT**



**SPEEDS**



**SHOP-TO-FIELD FLEXIBILITY  
MORE THAN 60 MATERIAL  
OPTIONS**



Pipemarking



ToughStripe area marking



General identification



Photoluminescent tape



Bin labelling



Safety labels...and many more!

## M710 Printer Specifications

Specifications	
Print Technology	Thermal Transfer
Print Resolution (dpi)	300 dpi
Print Speed (mm/sec)	76.20 mm/s
Colour Capability	Monocolour
Continuous vs Die-cut Labels	Continuous and Die-cut
Max. Label Width (mm)	50.80 mm
Max. Print Length	1016.00 mm
Connectivity Options	Standalone Use USB Bluetooth on selected models WiFi on selected models
Phones & Tablets Supported	Android devices with Android OS 6+ iPhone with iOS 10+ Only applicable to WiFi and Bluetooth models.
Software Compatibility	Brady Workstation, Express Labels App
Bar Code Type	QR Code Data Matrix Code 128 Code 39 EAN-8 EAN-13 Interleaved 2 of 5 UPC-A UPC-E More through software
Built-in Symbols	500+
Physical Properties	
Width x Height x Depth (mm)	240.03 x 345.20 x 116.75
Weight (kg)	2.45 kg
On Screen Indicators	Battery Life Ribbon and label part number recognition Supply Remaining Supply Remaining Error Messaging
Cutter	Auto Cutter
Warranty	2 years
Drop Test	Resistant to 1.2 metre drops, Sand & Dust

## M710 printer with software



### Design any label with Brady Workstation apps

Brady Workstation offers professional, intuitive apps to design quality product and cable labels and safety signs. Label design becomes easier, faster and quickly adaptable to new label norms thanks to centralised updates.



Order Reference	Art. No.	Description
M710-AZ-SFID	317826	MP71 AZERTY EU + BWS SFID Suite
M710-WB-AZ-SFID	317827	M710 AZERTY EU Wifi, BT + BWS SFID Suite
M710-WB-CYR-SFID	317828	M710 CYRILLIC Wifi, BT + BWS SFID Suite
M710-QY-EU-SFID	317829	M710 QWERTY EU + BWS SFID Suite
M710-WB-QY-EU-SFID	317830	M710 QWERTY EU Wifi, BT + BWS SFID Suite
M710-QY-UK-SFID	317831	M710 QWERTY UK + BWS SFID Suite
M710-WB-QY-UK-SFID	317832	M710 QWERTY UK Wifi, BT + BWS SFID Suite
M710-WB-QZ-SFID	317833	M710 QWERTZ EU Wifi, BT + BWS SFID Suite

## Brady Workstation Express Label App

Access files faster. Anywhere you work.



Label file created in the office



Labels pushed to the cloud



Labels printed in the field

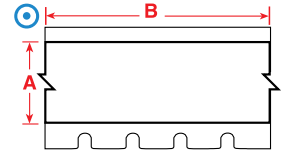
- ▶ **20+ barcode types**
- ▶ **85+ fonts**
- ▶ **1,400+ symbols**
- ▶ **Microsoft Excel data imports**
- ▶ **Label sequencing**
- ▶ **Label saving and sharing**
- ▶ **Accurate print preview**
- ▶ **Real-time printer status**



## B-595 high performance indoor/outdoor vinyl

- Brady's indoor/outdoor grade vinyl tape adheres well to pipes, walls, equipment, windows – most clean, dry surfaces.
- Conforms well to irregular, curved or rough surfaces – it even stands up to grease, oil and most industrial chemicals.
- 8 to 10\*\* year outdoor durability average in temperatures from -40°C to 82°C, can be applied as low as -18°C.

Diagram	Order Reference	Colour	Finish	Width A (mm)	Length B (m)	Labels per Roll	Recommended Ribbon
B-595: Vinyl							
	M7C-500-595-YL	Yellow	Gloss	12.70	15.24	1	R6000HF, R4400-WT
	M7C-1000-595-YL	Yellow	Gloss	25.40	15.24	1	R6000HF, R4400-WT
	M7C-2000-595-YL	Yellow	Gloss	50.80	15.24	1	R6000HF, R4400-WT
	M7C-500-595-WT	White	Gloss	12.70	15.24	1	R6000HF
	M7C-1000-595-WT	White	Gloss	25.40	15.24	1	R6000HF
	M7C-2000-595-WT	White	Gloss	50.80	15.24	1	R6000HF
	M7C-500-595-CL	Transparent	Gloss	12.70	15.24	1	R6000HF, R4400-WT
	M7C-1000-595-CL	Transparent	Gloss	25.40	15.24	1	R6000HF, R4400-WT
	M7C-2000-595-CL	Transparent	Gloss	50.80	15.24	1	R6000HF, R4400-WT
	M7C-500-595-TN	Tan	Gloss	12.70	15.24	1	R6000HF, R4400-WT
	M7C-1000-595-TN	Tan	Gloss	25.40	15.24	1	R6000HF, R4400-WT
	M7C-2000-595-TN	Tan	Gloss	50.80	15.24	1	R6000HF, R4400-WT
	M7C-500-595-SB	Sky Blue	Gloss	12.70	15.24	1	R6000HF, R4400-WT
	M7C-1000-595-SB	Sky Blue	Gloss	25.40	15.24	1	R6000HF, R4400-WT
	M7C-2000-595-SB	Sky Blue	Gloss	50.80	15.24	1	R6000HF, R4400-WT
	M7C-500-595-RD	Red	Gloss	12.70	15.24	1	R6000HF, R4400-WT
	M7C-1000-595-RD	Red	Gloss	25.40	15.24	1	R6000HF, R4400-WT
	M7C-2000-595-RD	Red	Gloss	50.80	15.24	1	R6000HF, R4400-WT
	M7C-500-595-PL	Purple	Gloss	12.70	15.24	1	R6000HF, R4400-WT
	M7C-1000-595-PL	Purple	Gloss	25.40	15.24	1	R6000HF, R4400-WT
	M7C-2000-595-PL	Purple	Gloss	50.80	15.24	1	R6000HF, R4400-WT
	M7C-500-595-PK	Pink	Gloss	12.70	15.24	1	R6000HF, R4400-WT
	M7C-1000-595-PK	Pink	Gloss	25.40	15.24	1	R6000HF, R4400-WT
	M7C-2000-595-PK	Pink	Gloss	50.80	15.24	1	R6000HF, R4400-WT
	M7C-500-595-OR	Orange	Gloss	12.70	15.24	1	R6000HF, R4400-WT
	M7C-1000-595-OR	Orange	Gloss	25.40	15.24	1	R6000HF, R4400-WT
	M7C-2000-595-OR	Orange	Gloss	50.80	15.24	1	R6000HF, R4400-WT
	M7C-500-595-OC	Ochre	Gloss	12.70	15.24	1	R6000HF, R4400-WT
	M7C-1000-595-OC	Ochre	Gloss	25.40	15.24	1	R6000HF, R4400-WT
	M7C-2000-595-OC	Ochre	Gloss	50.80	15.24	1	R6000HF, R4400-WT
	M7C-500-595-LB	Light Blue	Gloss	12.70	15.24	1	R6000HF, R4400-WT
	M7C-1000-595-LB	Light Blue	Gloss	25.40	15.24	1	R6000HF, R4400-WT
	M7C-2000-595-LB	Light Blue	Gloss	50.80	15.24	1	R6000HF, R4400-WT
	M7C-500-595-GY	Grey	Gloss	12.70	15.24	1	R6000HF, R4400-WT
	M7C-1000-595-GY	Grey	Gloss	25.40	15.24	1	R6000HF, R4400-WT
	M7C-2000-595-GY	Grey	Gloss	50.80	15.24	1	R6000HF, R4400-WT
	M7C-500-595-GN	Green	Gloss	12.70	15.24	1	R6000HF, R4400-WT
	M7C-1000-595-GN	Green	Gloss	25.40	15.24	1	R6000HF, R4400-WT
	M7C-2000-595-GN	Green	Gloss	50.80	15.24	1	R6000HF, R4400-WT
	M7C-500-595-GD	Gold	Gloss	12.70	15.24	1	R6000HF, R4400-WT
	M7C-1000-595-GD	Gold	Gloss	25.40	15.24	1	R6000HF, R4400-WT
	M7C-2000-595-GD	Gold	Gloss	50.80	15.24	1	R6000HF, R4400-WT
	M7C-500-595-BR	Brown	Gloss	12.70	15.24	1	R6000HF, R4400-WT
	M7C-1000-595-BR	Brown	Gloss	25.40	15.24	1	R6000HF, R4400-WT
	M7C-2000-595-BR	Brown	Gloss	50.80	15.24	1	R6000HF, R4400-WT
	M7C-500-595-BL	Blue	Gloss	12.70	15.24	1	R6000HF, R4400-WT
	M7C-1000-595-BL	Blue	Gloss	25.40	15.24	1	R6000HF, R4400-WT
	M7C-2000-595-BL	Blue	Gloss	50.80	15.24	1	R6000HF, R4400-WT
	M7C-500-595-BK	Black	Gloss	12.70	15.24	1	R4400-WT
	M7C-1000-595-BK	Black	Gloss	25.40	15.24	1	R4400-WT
	M7C-2000-595-BK	Black	Gloss	50.80	15.24	1	R4400-WT



\*\*Average expected outdoor life of product will depend on user definition of failure, climatic conditions, mounting techniques and material colour. The up to 8 to 10 year outdoor durability applies to the vinyl label stock only; ribbon durability will vary. A polyester overlaminate is recommended for harsh environments - long term exposure to wind and rain.



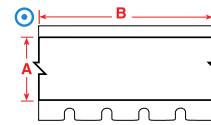
Order references with "C" (e.g. M7C) indicate continuous. Order references beginning with "B" indicate bulk rolls.



## B-584 reflective vinyl

- The reflective quality of this material makes it ideal for reading labels in low light conditions (with flashlights).

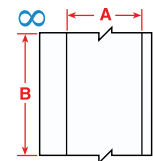
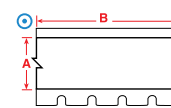
Diagram	Order Reference	Colour	Width A (mm)	Length B (m)	Recommended Ribbon
<b>B-584: Reflective Tape</b>					
	BMC-1000-584-YL	Yellow	25.40	22.86	R6000HF
	BMC-2000-584-YL	Yellow	50.80	22.86	R6000HF
	BMC-1000-584-WT	White	25.40	22.86	R6000HF
	BMC-2000-584-WT	White	50.80	22.86	R6000HF
	BMC-1000-584-OR	Orange	25.40	22.86	R6000HF
	BMC-2000-584-OR	Orange	50.80	22.86	R6000HF



## B-582/B-526 Phosphorescent polyester tapes

- Glow-in-the-dark material. Ideal for exit and directional signs, identification of fire alarms and extinguishers, low location egress pathway markings, and directional systems for escape or evacuation routes.

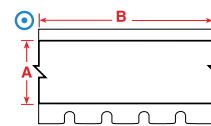
Diagram	Order Reference	Colour	Width A (mm)	Length B (m)	Recommended Ribbon
<b>B-526: Phosphorescent Polyester</b>					
	BM7C-1000-526	White	25.40	22.86	R10000
	BM7C-2000-526	White	50.80	22.86	R10000
<b>B-582: Phosphorescent Polyester</b>					
	BM7C-1000-582	Photoluminescent Green	25.40	22.86	R6000HF
	BM7C-2000-582	Photoluminescent Green	50.80	22.86	R6000HF



## B-483/B-634 ToughStripe area marking tape

- Create custom-printed floor labels, with easy 3-step process: print label, position on floor, apply overlaminates.
- Each kit includes 1 roll of B-483 tape and 1 roll of B-634 overlaminates.

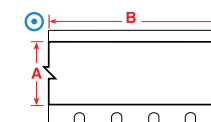
Diagram	Order Reference	Colour	Finish	Width A (mm)	Length B (m)	Recommended Ribbon
<b>B-483A/B-634: Polyester with Polyester Overlaminates</b>						
	M7-1000-483-YL-KT	Yellow	Gloss	25.40	15.24	R6000HF, R4400
	M7-2000-483-YL-KT	Yellow	Gloss	50.80	15.24	R6000HF, R4400
	M7-1000-483-WT-KT	White	Gloss	25.40	15.24	R6000HF
	M7-2000-483-WT-KT	White	Gloss	50.80	15.24	R4400-WT
	M7-1000-483-RD-KT	Red	Gloss	25.40	15.24	R6000HF, R4400
	M7-2000-483-RD-KT	Red	Gloss	50.80	15.24	R6000HF, R4400
	M7-1000-483-OR-KT	Orange	Gloss	25.40	15.24	R6000HF, R4400
	M7-2000-483-OR-KT	Orange	Gloss	50.80	15.24	R6000HF, R4400
	M7-1000-483-GN-KT	Green	Gloss	25.40	15.24	R6000HF, R4400
	M7-2000-483-GN-KT	Green	Gloss	50.80	15.24	R6000HF, R4400
	M7-1000-483-BL-KT	Blue	Gloss	25.40	15.24	R6000HF, R4400
	M7-2000-483-BL-KT	Blue	Gloss	50.80	15.24	R6000HF, R4400
	M7-1000-483-BK-KT	Black	Gloss	25.40	15.24	R4400-WT, R6000HF
	M7-2000-483-BK-KT	Black	Gloss	50.80	15.24	R4400-WT, R6000HF



## B-854 and B-855 ToughWash series labels

- Durable label construction resists harsh washdown environments and has been tested at washdown temperatures up to 80°C (175° F) and pressures up to 1500 PSI.
- B-854 is a metal detectable version, capable of being detected by commercially available metal detectors.

Diagram	Order Reference	Colour	Width A (mm)	Length B (m)	Recommended Ribbon
<b>B-854: Metal Detectable Polyester</b>					
	BM7C-2000-854-CAU	Black, Yellow on White	104.78		R6000HF
	BM7C-1000-854-WT	White	25.40	22.86	R6000HF
	BM7C-2000-854-WT	White	50.80	22.86	R6000HF
	BM7C-1000-854-YL	Yellow	25.40	22.86	R6000HF
	BM7C-2000-854-YL	Yellow	50.80	22.86	R6000HF
<b>B-855: Polyester</b>					
	BM7C-1000-855-WT	White	25.40	22.86	R6000HF
	BM7C-2000-855-WT	White	50.80	22.86	R6000HF
	BM7C-1000-855-YL	Yellow	25.40	22.86	R6000HF
	BM7C-2000-855-YL	Yellow	50.80	22.86	R6000HF

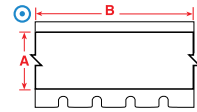




## B-581 repositionable vinyl

- Best choice for indoor marking where frequent repositioning is required, such as shelves. Special adhesive allows easy removal of label to re-apply again and again.

Diagram	Order Reference	Colour	Width A (mm)	Length B (m)	Recommended Ribbon
B-581: Vinyl					
⊙	M7C-500-581-WT	White	12.70	15.24	R6000HF
⊙	M7C-1000-581-WT	White	25.40	15.24	R6000HF
⊙	M7C-2000-581-WT	White	50.80	15.24	R6000HF
⊙	M7C-500-581-YL	Yellow	12.70	15.24	R6000HF
⊙	M7C-1000-581-YL	Yellow	25.40	15.24	R6000HF
⊙	M7C-2000-581-YL	Yellow	50.80	15.24	R6000HF

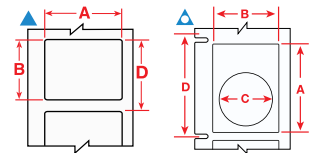


Order references with "C" (e.g. M7C) indicate continuous. Order references beginning with "B" indicate bulk rolls.



## B-7593 EPREP labels – engraved plate replacement labels

- BRADY EPREP labels are innovative labels specifically designed to replace engraved and plotted plates for identification of electrical components, electrical cabinets, push buttons, patch panels etc.



Roll Mounted



Fanfolded



Bulk Roll

Diagram	Order Reference	Colour	Finish	Width A (mm)	Height B (mm)	Hole Diameter C (mm)	Vertical Repeat D (mm)	Labels per Roll	Layout	Recommended Ribbon
B-7593: Polyethylene Foam Laminate Polyester										
△	M7-5-7593-BK	Black	Gloss	30.00	40.00	24.00	50.80	100	Fan-folded	R4400-WT
▲	M7-6-7593-BK	Black	Gloss	45.00	15.00	-	40.37	100	Fan-folded	R4400-WT
△	M7-5-7593-GN	Green	Gloss	30.00	40.00	24.00	50.80	100	Fan-folded	R6000HF
△	M7-5-7593-RD	Red	Gloss	30.00	40.00	24.00	50.80	100	Fan-folded	R6000HF
▲	M7-6-7593-RD	Red	Gloss	45.00	15.00	-	40.37	100	Fan-folded	R6000HF
▲	M7-1-7593-SL	Silver	Gloss	27.00	7.95	-	11.18	250		R6000HF
▲	M7-2-7593-SL	Silver	Gloss	27.00	12.45	-	15.63	250		R6000HF
▲	M7-3-7593-SL	Silver	Gloss	27.00	15.00	-	18.14	150		R6000HF
▲	M7-4-7593-SL	Silver	Gloss	27.00	18.00	-	21.25	150		R6000HF
△	M7-5-7593-SL	Silver	Gloss	30.00	40.00	24.00	50.80	100	Fan-folded	R6000HF
▲	M7-7-7593-SL	Silver	Gloss	35.00	18.00	-	21.49	100		R6000HF
▲	BM-06-7593-SL	Silver	Gloss	45.00	15.00	-	18.26	500		R6000HF
▲	M7-8-7593-SL	Silver	Gloss	48.00	19.00	-	22.46	125		R6000HF
▲	M7-1-7593-WT	White	Gloss	27.00	7.95	-	11.18	250		R6000HF
▲	M7-2-7593-WT	White	Gloss	27.00	12.45	-	15.63	250		R6000HF
▲	M7-3-7593-WT	White	Gloss	27.00	15.00	-	18.14	150		R6000HF
▲	M7-4-7593-WT	White	Gloss	27.00	18.00	-	21.25	150		R6000HF
△	M7-5-7593-WT	White	Gloss	30.00	40.00	24.00	50.80	100	Fan-folded	R6000HF
▲	M7-7-7593-WT	White	Gloss	35.00	18.00	-	21.49	100		R6000HF
▲	BM-06-7593-WT	White	Gloss	45.00	15.00	-	18.26	500		R6000HF
▲	M7-8-7593-WT	White	Gloss	48.00	19.00	-	22.46	125		R6000HF
△	M7-5-7593-YL	Yellow	Gloss	30.00	40.00	24.00	50.80	100	Fan-folded	R6000HF
▲	M7-7-7593-YL	Yellow	Gloss	35.00	18.00	-	21.49	100		R6000HF
▲	M7-6-7593-YL	Yellow	Gloss	45.00	15.00	-	40.37	100	Fan-folded	R6000HF

## B-569 High performance polyester tape

- Recommended for low-halide labeling onto stainless steel pipes and surfaces in harsh environments.
- Applies best to very smooth surfaces and ideal for mounting to rigid panels.

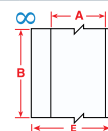


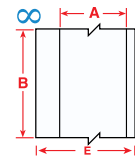
Diagram	Order Reference	Colour	Finish	Label Width A (mm)	Label Length B (m)	Labels per Roll	Printer Ribbon Series
B-569: Polyester							
∞	M7C-1000-569-BL	Blue	Gloss	25.40	15.24 m	1	R6000HF, R10000
∞	M7C-1000-569-GN	Green	Gloss	25.40	15.24 m	1	R6000HF, R10000
∞	M7C-1000-569-RD	Red	Gloss	25.40	15.24 m	1	R6000HF, R10000
∞	M7C-1000-569-WT	White	Gloss	25.40	15.24 m	1	R6000HF, R10000
∞	M7C-1000-569-YL	Yellow	Gloss	25.40	15.24 m	1	R6000HF, R10000
∞	M7C-2000-569-BL	Blue	Gloss	50.80	15.24 m	1	R6000HF, R10000
∞	M7C-2000-569-GN	Green	Gloss	50.80	15.24 m	1	R6000HF, R10000
∞	M7C-2000-569-RD	Red	Gloss	50.80	15.24 m	1	R6000HF, R10000
∞	M7C-2000-569-WT	White	Gloss	50.80	15.24 m	1	R6000HF, R10000
∞	M7C-2000-569-YL	Yellow	Gloss	50.80	15.24 m	1	R6000HF, R10000

## B-549 Cold temperature application material

- Special adhesive permanently adheres to extremely cold surfaces
- Ideal for cold storage warehouses, fridges, freezers and short-term outdoor use in winter
- Service temp: -40 °C to 100 °C
- Application temp: -23 °C to 100 °C



Diagram	Order Reference	Colour	Finish	Label Width A (mm)	Label Length B (m)	Printer Ribbon Series
B-549: Polyester						
∞	M7C-1000-549-WT	White	Gloss	25.40	15.24 m	R6000HF, R10000
∞	M7C-1000-549-YL	Yellow	Gloss	25.40	15.24 m	R6000HF, R10000
∞	M7C-2000-549-WT	White	Gloss	50.80	15.24 m	R6000HF, R10000
∞	M7C-2000-549-YL	Yellow	Gloss	50.80	15.24 m	R6000HF, R10000

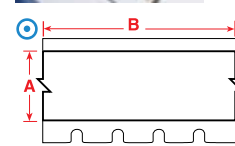


## B-530 security identification labels

- Tamper-resistant tape destructs into tiny fragments when being removed, makes any attempts to remove the label very difficult and time consuming.



Diagram	Order Reference	Colour	Width A (mm)	Length B (m)	Labels per Roll	Recommended Ribbon
B-530: Tamper-resistant Vinyl						
⊙	M7C-500-530	White	12.70	15.24	1	R6000HF
⊙	M7C-1000-530	White	25.40	15.24	1	R6000HF
⊙	M7C-2000-530	White	50.80	15.24	1	R6000HF

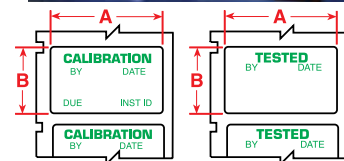


## B-423 and B-428 pre-printed labels

- M710 printable labels with pre-printed headers allow customers to print variable information next to highly visible titles.



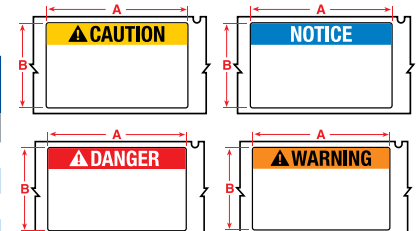
Order Reference	Colour	Finish	Width A (mm)	Height B (mm)	Labels per Roll	Recommended Ribbon
B-423: Polyester						
M7-30-423-TEST	Green on White	Gloss	38.10	19.05	250	R6000HF
B-428: Metallised Polyester						
M7-30-428-CALI	Green on Grey	Matt	38.10	19.05	250	R4300



## B-483A pre-printed labels

- M710 printable labels with pre-printed headers allow customers to print variable information next to highly visible titles.

Order Reference	Colour	Finish	Width A (mm)	Height B (mm)	Labels per Roll	Recommended Ribbon
B-483A: Polyester						
M7-38-483-CAUTION	Black, Yellow on White	Gloss	101.60	48.26	100	R6000HF
M7-38-483-DANGER	Red on White	Gloss	101.60	48.26	100	R6000HF
M7-38-483-NOTICE	Blue on White	Gloss	101.60	48.26	100	R6000HF
M7-38-483-WARNING	Black, Orange on White	Gloss	101.60	48.26	100	R6000HF

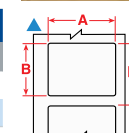


## B-424 paper labels

- Economical choice for light duty general ID.
- White finish and matt topcoat.
- Excellent contrast and smear resistance for barcode printing.



Diagram	Order Reference	Colour	Width A (mm)	Height B (mm)	Labels per Roll	Recommended Ribbon
B-424: Paper						
▲	M7-20-424	White	25.40	50.80	100	R4300
▲	BM-20-424	White	50.80	25.40	1000	R4300

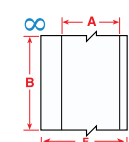


## B-509 Printable magnetic supply

- Non-adhesive magnetic material that can be printed on directly
- Ideal for reusable and repositionable identification applications



Diagram	Order Reference	Colour	Finish	Label Width A (mm)	Label Length B (m)	Printer Ribbon Series
B-509: Magnetic Polyester						
∞	BM7C-1000-509-WT	White	Matt	25.40	7.62	R10000
∞	BM7C-1000-509-YL	Yellow	Matt	25.40	7.62	R10000
∞	BM7C-1800-509-WT	White	Matt	45.72	7.62	R10000
∞	BM7C-1800-509-YL	Yellow	Matt	45.72	7.62	R10000



## M710 ribbons

Order Reference	Colour	Roll Width (mm)	Roll Length (m)	Formulation	Notes / Details
M7-R10000	Black	50.00	45.72	Resin	Featuring a 5-second "drop and click" supply change, this smear-proof M710 Ribbon needs no threading or calibration. And, it's built super-tough for outdoor and industrial use.
M7-R10000-BL	Blue	50.00	45.72	Resin	Featuring a 5-second "drop and click" supply change, this smear-proof M710 Ribbon needs no threading or calibration. And, it's the ink is super-tough for outdoor and industrial use.
M7-R10000-GN	Green	50.00	45.72	Resin	Featuring a 5-second "drop and click" supply change, this smear-proof M710 Ribbon needs no threading or calibration. And, it's built super-tough for outdoor and industrial use.
M7-R10000-RD	Red	50.00	45.72	Resin	Featuring a 5-second "drop and click" supply change, this smear-proof M710 Ribbon needs no threading or calibration. And, it's built super-tough for outdoor and industrial use.
M7-R10000-WT	White	50.00	45.72	Resin	Featuring a 5-second "drop and click" supply change, this smear-proof M710 needs no threading or calibration. And, it's built super-tough for outdoor and industrial use.
M7-R10000-YL	Yellow	50.00	45.72	Resin	Featuring a 5-second "drop and click" supply change, this smear-proof M710 Ribbon needs no threading or calibration. And, it's built super-tough for outdoor and industrial use.
M7-R4400-WT	White	50.00	45.72	Resin	M710 Series snap-in print ribbons enable 5-second ribbon supply changes. No calibrating, no threading, no waste, no hassles and the ink always faces the right direction!
M7-R6000	Black	50.00	45.72	Resin	M710 Series snap-in print ribbons enable 5-second ribbon supply changes. No calibrating, no threading, no waste, no hassles and the ink always faces the right direction!
M7-R6200	Black	50.00	45.72	Resin	M710 Series snap-in print ribbons enable 5-second ribbon supply changes. No calibrating, no threading, no waste, no hassles and the ink always faces the right direction!
M7-R6400	Black	50.00	45.72	Resin	M710 Series snap-in print ribbons enable 5-second ribbon supply changes. No calibrating, no threading, no waste, no hassles and the ink always faces the right direction!
M7-R6600	Black	50.00	45.72	Resin	M710 Series snap-in print ribbons enable 5-second ribbon supply changes. No calibrating, no threading, no waste, no hassles and the ink always faces the right direction!
M7-R6800-WT	White	50.00	36.58	Resin	M710 Series snap-in print ribbons enable 5-second ribbon supply changes. No calibrating, no threading, no waste, no hassles and the ink always faces the right direction!
M7-R6900-BL	Blue	50.00	45.72	Resin	M710 Series snap-in print ribbons enable 5-second ribbon supply changes. No calibrating, no threading, no waste, no hassles and the ink always faces the right direction!
M7-R6900-GN	Green	50.00	45.72	Resin	M710 Series snap-in print ribbons enable 5-second ribbon supply changes. No calibrating, no threading, no waste, no hassles and the ink always faces the right direction!
M7-R6900-MA	Magenta	50.00	45.72	Resin	M710 Series snap-in print ribbons enable 5-second ribbon supply changes. No calibrating, no threading, no waste, no hassles and the ink always faces the right direction!
M7-R6900-RD	Red	50.00	45.72	Resin	M710 Series snap-in print ribbons enable 5-second ribbon supply changes. No calibrating, no threading, no waste, no hassles and the ink always faces the right direction!
M7-R6900-YL	Yellow	50.00	45.72	Resin	M710 Series snap-in print ribbons enable 5-second ribbon supply changes. No calibrating, no threading, no waste, no hassles and the ink always faces the right direction!
M7-R4300	Black	50.00	45.72	Wax/Resin	M710 Series snap-in print ribbons enable 5-second ribbon supply changes. No calibrating, no threading, no waste, no hassles and the ink always faces the right direction!
M7-R6700-WT	White	50.00	45.72	Wax/Resin	M710 Series snap-in print ribbons enable 5-second ribbon supply changes. No calibrating, no threading, no waste, no hassles and the ink always faces the right direction!

## M710 at a glance



Watch the how to videos on our Brady YouTube channel.



**2 YEAR WARRANTY**





## i3300, S3100, S3700 printers

- 22 BradyPrinter i3300 Industrial Label Printer
- 23 BradyPrinter S3100 Sign & Label Printer
- 24-25 S3700 Sign & Label Printer
- 26 Safety sliders consumable kit
- 26 CLP/GHS consumable kit
- 27 Pipe marking consumable kit
- 27 General safety consumable kit
- 27 i3300, S3100, i3300-, S3100-, S3700 floor marking kit
- 28 B-595 high performance indoor/outdoor vinyl
- 29-30 B-569 high performance polyester
- 30 Premask application tape B-595 pre-printed right-to-know chemical labels
- 30 B-595 pre-printed pre-cut blank sign headers
- 31 B-595 pre-printed right-to-know chemical labels
- 31 B-851 non-adhesive pre-printed and pre-cut safety tags
- 32 B-7569 pre-printed GHS/CLP chemical labels
- 33 B-483/B-634 ToughStripe floor marking tape with overlaminate
- 34 B-854 and B-855 ToughWash washdown resistant labels
- 34 B-584 retro reflective tape
- 35 Continuous tapes for general identification
- 35 B-526 BradyGlo high-intensity photoluminescent tape
- 35 B-565 high temp metallised polyester tape
- 35 B-595 and B-7569 pre-cut blank labels
- 36 B-851 non-adhesive tag stock
- 36 Coloured nylon ties
- 36 B-509 printable magnetic supply
- 36 B-549 cold temperature application material
- 37 B-7569 indoor/outdoor vinyl
- 38 B-581 repositionable vinyl
- 38 B-593 raised profile labels - push button style
- 39 B-593 raised profile labels
- 40 Print ribbons
- 41 i3300/S3100 at a glance
- 42 S3700 at a glance



## BradyPrinter i3300 INDUSTRIAL LABEL PRINTER

The BradyPrinter i3300 Industrial Label Printer is a completely hassle free, easy to use PC-based printer. It can print a full range of safety and facility labels and signs as well as die cut labels for wire identification, product identification and laboratory identification.

### Print a huge range of labels & signs

With the BradyPrinter i3300, you can print a huge range of reliable labels and signs at your location in monocolour. More than 50 different Brady label materials are compatible with the BradyPrinter i3300. Labels & signs that can be printed with the BradyPrinter i3300 include:

- wire & cable identification labels
- product and laboratory identification labels
- safety and facility signs

These can be used both in- and outdoor, and include specialty solutions like ToughWash labels and ToughStripe floor marking.

### Designed to last

The BradyPrinter i3300 prints on Brady's industrial grade labels that have been designed to last in challenging conditions. All Brady labels have been tested in line with international ASTM test methods and a technical data sheet is available for every material.

### Extremely easy to use

The BradyPrinter i3300 is extremely easy to use and features auto-calibration and automatic label material setup. This will enable you to immediately start printing the signs and labels you need. Switching to another label material is easy and extremely fast thanks to the printer's 'drop-in' label materials and matching ink ribbons that can be switched out in less than 20 seconds. When used with Brady Workstation apps, a wide variety of sign & label design options becomes available.



Learn more about the BradyPrinter i3300 on:  
[www.bradyeurope.com/i3300](http://www.bradyeurope.com/i3300)

## i3300 printers

Order Ref.	Art. No.	Description
I3300-C-EU	149553	i3300 Industrial Label Printer- EU
I3300-SPS-EU	302754	i3300 Industrial Label Printer-EU with Barcode Reader and Brady Workstation Scan & Print Suite
I3300-C-EU-SFI	241118	i3300 Industrial Label Printer- EU with Brady Workstation SFID Suite
I3300-C-UK	149555	i3300 Industrial Label Printer- UK
I3300-C-UK-SFI	241120	i3300 Industrial Label Printer- UK with Brady Workstation SFID Suite
I3300-300-C-US	149551	i3300 Industrial Label Printer- US
I3300-C-US-SFIDS	241116	i3300 Industrial Label Printer- US with Brady Workstation SFID Suite
I3300-C-EU-WF	149554	i3300 Industrial Label Printer with Wifi- EU
I3300-SPS-EU-WF	302672	i3300 Industrial Label Printer with Wifi-EU, Barcode Reader and Brady Workstation Scan & Print Suite
I3300-C-EU-W-S	241119	i3300 Industrial Label Printer with Wifi- EU with Brady Workstation SFID Suite
I3300-C-UK-WF	149556	i3300 Industrial Label Printer with Wifi- UK
I3300-SPS-UK-WF	302673	i3300 Industrial Label Printer with Wifi-UK, Barcode Reader and Brady Workstation Scan & Print Suite
I3300-C-UK-W-S	241121	i3300 Industrial Label Printer with Wifi- UK with Brady Workstation SFID Suite
I3300-300-C-US-WF	149552	i3300 Industrial Label Printer with Wifi - US
I3300-C-US-W-SFIDS	241117	i3300 Industrial Label Printer with Wifi- US with Brady Workstation SFID Suite

This i3300 printer comes in a cardboard box. It ships with a power cord, a Brady Workstation Basic Suite, a USB cable, a product CD holding the manual, a cleaning kit and a printed quick start guide



The Basic Suite is included with every printer, download it: [Workstation.BradyID.com/Free](http://Workstation.BradyID.com/Free)



Create custom signs, labels and pipemarkers with [WorkStation.BradyID.com/SFID](http://WorkStation.BradyID.com/SFID)

## i3300 accessories

Order Ref.	Art. No.	Description
Squeegee	036612	Squeegee
B30-TROLLEY	120994	Trolley for BBP3x,S3xxx,i3300
PCK-6	133251	Printer Cleaning Kit, Thermal Transfer Printers
B31-WIPER	142114	Media Wiper 5 Pack
B31-CCT	142116	Cutter Cleaning Tool for BBP30, BBP31, BBP33, S3100 and i3300 printer
Supplies Carrying Case	999834	Supplies Carrying Case

Printer specifications	
Language Support	Bulgarian, Chinese (Simplified), Chinese (Traditional), Croatian, Czech, Danish, Dutch, English (US), Estonian, Finnish, French (Canada), French, German, Hungarian, Italian, Korean, Norwegian (Bokmål), Polish, Portuguese (Brazil), Portuguese, Romanian, Russian, Spanish (Mexico), Spanish, Swedish, Thai, Turkish
Software Compatibility	Brady Workstation Windows based driver for 3rd party software use
Bar Code Type	Code 128A, Code 128B, Code 128C, Code 39, Code 93, EAN-13, EAN-8, HIBC, nterleaved 2 of 5, Interleaved 2 of 5 with check digit, JAN-13, JAN-8, UPC-A
Colour Capability	Monocolour
Stand-alone Printing (Detached from PC)	Peripheral
Connectivity Options	Ethernet, USB, Wi-Fi
Print Speed (mm/sec)	101.60 mm/s
Print Technology	Thermal Transfer
Print Resolution (dpi)	300 dpi
Smart Cell	Yes
Max. Label Width (mm)	107.95
Max. Print Width (mm)	101.98
Materials Supported	FreezerBondz™ Polyester, Heat-shrink Polyolefin, High Temperature Heat, shrink Polyvinylidene Fluoride Sleeve, Magnetic Polyester, Metal-detectable, Polyester, Metallic, Non-metal Polyester, Metallised Polyester, Metallised, Polyester with Polyester Overlamine, Nylon Cloth, Paper, Phosphorescent Polyester, Polyester, Polyester with Polyester Overlamine, Polyimide, Polyolefin, Polypropylene, Polyvinylfluoride, Reflective Tape, Self-laminating Polyester, Self-laminating Vinyl, StainerBondz™ Polyester, Static Dissipative Polyester, Tamper-evident Metallised Polyester, Vinyl, Vinyl Cloth
Display	Colour LCD Touchscreen
Cutter	Auto Cutter
Width x Height x Depth (mm)	228.60 x 241.30 x 304.80
Power Supply	AC Adaptor
Weight (kg)	5.22 kg

## BradyPrinter S3100 SIGN & LABEL PRINTER

With the S3100 Sign & Label Printer, you can print a wide range of signs and labels to increase safety and efficiency in any workplace. Safety signs, floor marking, 5S labels, lean labels, labels to identify racks, doors, stairs, bins, desks and chairs and CLP-labels to identify chemicals can all be printed with the S3100 at your location whenever you need them.

- Intuitive built-in features offer ease of use so anyone can walk up and print labels
- Ideal for centralised locations and lean/5S events
- Compatible with powerful Brady Workstation label apps for added versatility
- “Drop in ribbons and labels mean no complicated threading, assembling spindles, sensor adjustment or calibration steps
- You can get on with the job faster, giving you more time for other tasks



Consult the video of the S3100 Sign & Label Printer on [www.bradyeurope.com/S3100](http://www.bradyeurope.com/S3100)



### S3100 kits

Order Reference	Art. No.	Description
S3100-QY-UK-W-SFID	198575	S3100 Sign and Label Printer with Wifi - QWERTY UK with BWS SFIDS
S3100-QY-UK-SFIDS	198576	S3100 Sign and Label Printer - QWERTY UK with BWS SFIDS
S3100-QY-EU-W-SFID	198577	S3100 Sign and Label Printer with Wifi - QWERTY EU with BWS SFIDS
S3100-QY-EU-SFIDS	198578	S3100 Sign and Label Printer - QWERTY EU with BWS SFIDS
S3100-AZ-W-SFIDS	198579	S3100 Sign and Label Printer with Wifi - AZERTY with BWS SFIDS
S3100-AZ-SFIDS	198580	S3100 Sign and Label Printer - AZERTY with BWS SFIDS
S3100-CYR-W-SFIDS	198581	S3100 Sign and Label Printer with Wifi - CYRILLIC with BWS SFIDS
S3100-QZ-W-SFIDS	198582	S3100 Sign and Label Printer with Wifi - QWERTZ with BWS SFIDS
S3100-QZ-SFIDS	198583	S3100 Sign and Label Printer - QWERTZ with BWS SFIDS
S3100-W-SFIDS	198584	S3100 Sign and Label Printer with Wifi - QWERTY US with BWS SFIDS
S3100-SFIDS	198585	S3100 Sign and Label Printer - QWERTY US with BWS SFIDS

### S3100 printers

Order Reference	Art. No.	Description
S3100-QZ-W	149118	S3100 Sign and Label Printer with Wifi - QWERTZ
S3100-QY-UK-W	149119	S3100 Sign and Label Printer with Wifi - QWERTY UK
S3100-W	149121	S3100 Sign and Label Printer with Wifi - QWERTY US
S3100-AZ-W	149122	S3100 Sign and Label Printer with Wifi - AZERTY
S3100-CYR-W	149123	S3100 Sign and Label Printer with Wifi - CYRILLIC
S3100-QY-EU-W	149127	S3100 Sign and Label Printer with Wifi - QWERTY EU
S3100	149120	S3100 Sign and Label Printer - QWERTY US
S3100-QY-EU	149126	S3100 Sign and Label Printer - QWERTY EU
S3100-AZ	149517	S3100 Sign and Label Printer - AZERTY
S3100-QZ	149519	S3100 Sign and Label Printer - QWERTZ

### S3100 accessories

Order Reference	Art. No.	Description
999834	999834	Supplies Carrying Case
B31-CCT	142116	Cutter Cleaning Tool for BBP30, BBP31, BBP33, S3100 and i3300 printer
B31-DC	142117	BBP31 Dust Cover
B31-WIPER	142114	Media Wiper 5 Pack
BBP31/33 TROLLEY	120994	Trolley for BBP3x, S3xxx, i3300
PCK-6	133251	Printer Cleaning Kit, Thermal Transfer Printers
SQUEEGEE	036612	Squeegee



The Basic Suite is included with every printer, download it: [Workstation.BradyID.com/Free](http://Workstation.BradyID.com/Free)



Create custom signs, labels and pipemarkers with [WorkStation.BradyID.com/SFID](http://WorkStation.BradyID.com/SFID)





## S3700 Sign & Label Printer

Order Reference	Art. No.	Description
S3700-WB-QWERTZ	176427	S3700 Multicolour & Cut Sign and Label Printer with QWERTZ keyboard, Wifi and Bluetooth enabled
S3700-QWERTZ	176428	S3700 Multicolour & Cut Sign and Label Printer with QWERTZ keyboard
S3700-WB-AZERTY	176429	S3700 Multicolour & Cut Sign and Label Printer with AZERTY keyboard, Wifi and Bluetooth enabled
S3700-AZERTY	176430	S3700 Multicolour & Cut Sign and Label Printer with AZERTY Keyboard
S3700-WB-QWERTY-EU	176431	S3700 Multicolour & Cut Sign and Label Printer with QWERTY EU keyboard, Wifi and Bluetooth enabled
S3700-QWERTY-EU	176432	S3700 Multicolour & Cut Sign and Label Printer with QWERTY EU keyboard
S3700-WB-QWERTY-UK	176433	S3700 Multicolour & Cut Sign and Label Printer with QWERTY UK keyboard, Wifi and Bluetooth enabled
S3700-QWERTY-UK	176434	S3700 Multicolour & Cut Sign and Label Printer with QWERTY UK keyboard
S3700-WB-CYRILLIC	176435	S3700 Multicolour & Cut Sign and Label Printer with CYRILLIC keyboard, Wifi and Bluetooth enabled
S3700-CYRILLIC	176436	S3700 Multicolour & Cut Sign and Label Printer with CYRILLIC keyboard

Prints on a variety of material options so you can create signs and labels for a variety of applications



The Basic Suite is included with every printer, download it: Workstation. [BradyID.com/Free](http://BradyID.com/Free)

## BradyPrinter S3700

### SIGN & LABEL PRINTER

Brady's sign and label printers give you the power to make signs and labels in the colours and shapes you need to make an impact – right at your own facility and right when you need them. With remarkable multicolour printing, versatile shape-cutting capabilities and impressively fast print speeds, you won't remember how you lived without one of these printers.

#### Multiple print colours

Multicolour print capabilities make it ideal for creating impactful safety signs, lockout tags, warning labels and more in a single pass

#### Shape cutting

Built in XY-cutter allows for the creation of die-cut shapes and text that gives the flexibility to choose where to place new messaging

#### Label making made easy

Label creation is even faster with the quick setup and print speeds that come with print smart technology from BradyPrints on a variety of material options so you can create signs and labels for a variety of applications



Printer comparison guide can be found on **pages 6 & 7**

#### Automatic label setup

Printers read critical information from the supply cartridge and then automatically set it up so you can start printing immediately

No more calibration or wasted labels, no print speed/burn temperature trial labels, no scrolling through screens to select a label and no wasted time setting up label dimensions or text size

#### 20-second material changeovers

"Drop in" ribbons and labels mean no complicated threading, assembling spindles, sensor adjustment or calibration steps

You can get on with the job faster, giving you more time for other tasks



Create custom signs, labels and pipemarkers with WorkStation. [BradyID.com/SFID](http://BradyID.com/SFID)





## Printer specifications

Language Support	English (US), French, Portuguese, Spanish, Bahasa (Indonesian), Bahasa Malay, Czech, Danish, German, Estonian, Croatian, Italian, Hungarian, Dutch, Norwegian (Bokmål), Polish, Romanian, Slovak, Slovenian, Finnish, Swedish, Vietnamese, Turkish, Bulgarian, Russian, Korean, Chinese (Traditional & Simplified), Thai, Japanese
Software Compatibility	Brady Workstation, Express Labels Mobile App, Windows based driver for 3rd party software use
Bar Code Type	Code 128 Auto, Code 39, Interleaved 2 of 5, More through Brady WorkStation, EAN-13, UPC-A, PDF417, QR code
Recommended Usage per Day	600
Built-in Symbols	664
Colour Capability	Multicolour; Monocolour
Stand-alone Printing (Detached from PC)	Mobile device connected Stand-alone Peripheral
Connectivity Options	Bluetooth, Wi-Fi, Ethernet, USB
Internal Memory Capacity	512 MB
Print Speed (mm/sec)	127.00 mm/s
Print Technology	Thermal Transfer
Print Resolution (dpi)	300 dpi
Text Sizes (pt)	4 - 600 pt
Max. Label Width (mm)	107.95
Max. Print Width (mm)	101.60
Materials Supported	Magnetic Polyester, Metal-detectable Polyester, Metallic, Non-metal Polyester, Metallised Polyester, Paper, Phosphorescent Polyester, Polyester, Polyester with Polyester Overlamine, Polyimide, Polyvinylfluoride, Reflective Tape, Tamper-evident Metallised Polyester, Transfer Tape, Vinyl, Vinyl Cloth, Heavy Duty Polyester
Display	Colour LCD Touchscreen
Cutter	XY Cutter and Auto Cutter
Dimensions	482.60 mm (W) x 279.40 mm (H) x 361.95 mm (D)
Power Supply	AC Adaptor
Weight (kg)	16.74 kg

## i3300, S3100 and S3700 accessories

Printer Compatibility	Order Reference	Art. No.	Description
S3100	ASSY, PKG, ACCESSORY, STYLUS, PLA	142115	Replacement Stylus 3 Pack
S3100	B31-DC	142117	S3100 Dust Cover
S3000; S3100	B30-TROLLEY	120994	Trolley for S3100, i3300
S3000; S3100	B31-CCT	142116	Cutter Cleaning Tool for BBP30, BBP31, BBP33, S3100, i3300, S3700
S3100; BBP35; BBP37	NET-LAN	142267	LAN Network Card
S3100; BBP35; BBP37	NET-WIFI-LAN	142268	WiFi/ LAN Network Card
S3000; S3100; BBP35; BBP37	PCK-6	133251	Printer Cleaning Kit - Thermal Transfer Printers
S3000; S3100; BBP35; BBP37	B31-WIPER	142114	Media Wiper 5 Pack
S3000; S3100; BBP35; BBP37	Squeegee	036612	Squeegee



Multicolour safety signs



Pipe markers



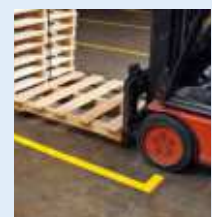
Machine safety labels



GHS/CLP labels



Safety tags



Floor marking



## Safety sliders consumable kit

Print these blank rigid boards for use in Brady's flexible Safety Slider facility communication system. Two versions exist for this kit, one for the BBP30, BBP31, i3300, S3100, BBP35, BBP37 printers and one for the BBP85 printer.



Order Reference	Description
B30-RIGID SIGN-KIT	Rigid signs panel kit for BBP3x Printers

This kit includes one each of the following parts:

Order Reference	Description	Colour	Size - Width A (mm)	Size - Height B (mm)	Size - Length B (m)	Labels per Roll
B30-R10000	Ribbon(s)	Black	110.00	-	60.90	1
B30-R10000-BL	Ribbon(s)	Blue	110.00	-	60.90	1
B30-R10000-GN	Ribbon(s)	Green	110.00	-	60.90	1
B30-R10000-RD	Ribbon(s)	Red	110.00	-	60.90	1
B30-R10000-YL	Ribbon(s)	Yellow	110.00	-	60.90	1
B30C-4000-7569-WT	Roll(s)	White	101.00	-	30.00	1
SLIDER BOARD-PVC-296x650mm-BLANK-4xA5	Sign(s)	White	296.00	650.00	-	1
SLIDER INSERT-PP-148x210mm-BLANK	Sign(s)	White	148.00	210.00	-	1
SLIDER TITLE-PP-296x150mm-BLANK	Sign(s)	White	296.00	150.00	-	1

Compatible with BBP37, BBP35, BBP30, i3300, BBP31 & S3100 printers.



## CLP/GHS consumable kit

Label chemicals in compliance with the chemicals classification & labelling legislation.



Order Reference	Description
B30-CLP-KIT	Pre-printed GHS/CLP Chemical Labels kit for BBP3x Printers

This kit includes one each of the following parts:

Order Reference	Description	Size - Width A (mm)	Size - Height B (mm)	Size - Length B (m)	Labels per Roll
B30-R10000	Ribbon(s)	110.00	-	60.90	1
B30-260-7569-CLP4B	Label(s)	55.00	85.00	-	340
B30-261-7569-CLP4B	Label(s)	75.00	110.00	-	270
B30-262-7569-CLP4B	Label(s)	105.00	155.00	-	200

Compatible with S3700, BBP30, i3300, BBP31 & S3100 printers.

## Pipe marking consumable kit

Print these durable tapes on-site and in line with legislation and specific industry standards.



Order Reference	Description
B30-PM-KIT	Pipe marking kit for BBP3x Printers

This kit includes one each of the following parts:

Order Reference	Description	Colour	Size - Width A (mm)	Size - Length B (m)	Labels per Roll
B30-R10000	Ribbon(s)	Black	110.00	60.90	1
B30-R10000-WT	Ribbon(s)	White	110.00	60.90	1
B30C-4000-595-BL	Roll(s)	Blue	101.00	30.40	1
B30C-4000-595-BR	Roll(s)	Brown	101.00	30.40	1
B30C-4000-595-GN	Roll(s)	Green	101.00	30.40	1
B30C-4000-595-PL	Roll(s)	Purple	101.00	30.40	1
B30C-4000-595-RD	Roll(s)	Red	101.00	30.40	1
B30C-4000-595-YL	Roll(s)	Yellow	101.00	30.40	1

Compatible with BBP37, BBP35, BBP30, i3300, BBP31 & S3100 printers.

## General safety consumable kit

Use these blank labels to quickly create compliant mandatory, prohibition, warning and emergency signage for your facility.



Order Ref.	Description
B30-SAFETY-KIT	General safety kit for BBP3x Printers

This kit includes one each of the following parts:

Order Reference	Description	Colour	Size - Width A (mm)	Size - Length B (m)	Labels per Roll
B30-R10000	Ribbon(s)	Black	110.00	60.90	1
B30-R10000-BL	Ribbon(s)	Blue	110.00	60.90	1
B30-R10000-GN	Ribbon(s)	Green	110.00	60.90	1
B30-R10000-RD	Ribbon(s)	Red	110.00	60.90	1
B30-R10000-YL	Ribbon(s)	Yellow	110.00	60.90	1
B30C-4000-595-WT	Roll(s)	White	101.00	30.40	1
B30C-4000-595-YL	Roll(s)	Yellow	101.00	30.40	1

Compatible with BBP37, BBP35, BBP30, i3300, BBP31 & S3100 printers.

## i3300, S3100, i3300-, S3100-, S3700 floor marking kit

Create custom-printed floor labels using your Brady printer. This kit allows you to place printable messages on the floor. The floor marking roll is supplied with a separate roll of B-634 Polyester Overlaminates to protect your legend.



Order Reference	Art. No.	Description
B30-FLOOR-KIT	199986	Floor marking kit for BBP35/BBP37/S3xxx/i3300 printers



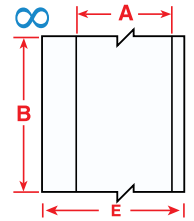
## B-595 high performance indoor/outdoor vinyl

For general facility and safety identification: our best industrial vinyl yet

- Durable, low-shrink vinyl with our most aggressive adhesive
- Conforms to irregular, curved, rough and highly textured surfaces (painted cinder blocks, uneven wood, textured plastics, paper-jacketed pipes, powder-coated surfaces)
- Adheres to “difficult” low-surface energy items (PVC piping, blow-moulded equipment cases, ABS plastics, recycled plastics)



Diagram	Order Reference	Colour	Width A (mm)	Length B (m)	Labels per Roll	Recommended Ribbon
∞	B30C-500-595-YL	Yellow	12.70	30.40	1	B30-R10000
∞	B30C-1125-595-YL	Yellow	29.00	30.40	1	B30-R10000
∞	B30C-2250-595-YL	Yellow	57.00	30.40	1	B30-R10000
∞	B30C-3000-595-YL	Yellow	75.00	30.40	1	B30-R10000
∞	B30C-4000-595-YL	Yellow	101.00	30.40	1	B30-R10000
∞	B30C-500-595-WT	White	12.70	30.40	1	B30-R10000
∞	B30C-1125-595-WT	White	29.00	30.40	1	B30-R10000
∞	B30C-2250-595-WT	White	57.00	30.40	1	B30-R10000
∞	B30C-3000-595-WT	White	75.00	30.40	1	B30-R10000
∞	B30C-4000-595-WT	White	101.00	30.40	1	B30-R10000
∞	B30C-500-595-CL	Transparent	12.70	30.40	1	B30-R10000
∞	B30C-1125-595-CL	Transparent	29.00	30.40	1	B30-R10000
∞	B30C-2250-595-CL	Transparent	57.00	30.40	1	B30-R10000
∞	B30C-4000-595-CL	Transparent	101.00	30.40	1	B30-R10000
∞	B30C-500-595-RD	Red	12.70	30.40	1	B30-R10000-WT
∞	B30C-1125-595-RD	Red	29.00	30.40	1	B30-R10000-WT
∞	B30C-2250-595-RD	Red	57.00	30.40	1	B30-R10000-WT
∞	B30C-4000-595-RD	Red	101.00	30.40	1	B30-R10000-WT
∞	B30C-500-595-PL	Purple	12.70	30.40	1	B30-R10000-WT
∞	B30C-1125-595-PL	Purple	29.00	30.40	1	B30-R10000-WT
∞	B30C-2250-595-PL	Purple	57.00	30.40	1	B30-R10000-WT
∞	B30C-4000-595-PL	Purple	101.00	30.40	1	B30-R10000-WT
∞	B30C-500-595-OR	Orange	12.70	30.40	1	B30-R10000
∞	B30C-1125-595-OR	Orange	29.00	30.40	1	B30-R10000
∞	B30C-2250-595-OR	Orange	57.00	30.40	1	B30-R10000
∞	B30C-4000-595-OR	Orange	101.00	30.40	1	B30-R10000
∞	B30C-1125-595-OC	Ochre	29.00	30.40	1	B30-R60000C
∞	B30C-2250-595-OC	Ochre	57.00	30.40	1	B30-R60000C
∞	B30C-4000-595-OC	Ochre	101.00	30.40	1	B30-R60000C
∞	B30C-500-595-GY	Grey	12.70	30.40	1	B30-R10000
∞	B30C-1125-595-GY	Grey	29.00	30.40	1	B30-R10000
∞	B30C-2250-595-GY	Grey	57.00	30.40	1	B30-R10000
∞	B30C-4000-595-GY	Grey	101.00	30.40	1	B30-R10000
∞	B30C-500-595-GN	Green	12.70	30.40	1	B30-R10000-WT
∞	B30C-1125-595-GN	Green	29.00	30.40	1	B30-R10000-WT
∞	B30C-2250-595-GN	Green	57.00	30.40	1	B30-R10000-WT
∞	B30C-4000-595-GN	Green	101.00	30.40	1	B30-R10000-WT
∞	B30C-500-595-GD	Gold	12.70	30.40	1	B30-R10000
∞	B30C-1125-595-GD	Gold	29.00	30.40	1	B30-R10000
∞	B30C-2250-595-GD	Gold	57.00	30.40	1	B30-R10000
∞	B30C-4000-595-GD	Gold	101.00	30.40	1	B30-R10000
∞	B30C-500-595-BR	Brown	12.70	30.40	1	B30-R10000-WT
∞	B30C-1125-595-BR	Brown	29.00	30.40	1	B30-R10000-WT
∞	B30C-2250-595-BR	Brown	57.00	30.40	1	B30-R10000-WT
∞	B30C-4000-595-BR	Brown	101.00	30.40	1	B30-R10000-WT
∞	B30C-500-595-BL	Blue	12.70	30.40	1	B30-R10000-WT
∞	B30C-1125-595-BL	Blue	29.00	30.40	1	B30-R10000-WT
∞	B30C-2250-595-BL	Blue	57.00	30.40	1	B30-R10000-WT
∞	B30C-4000-595-BL	Blue	101.00	30.40	1	B30-R10000-WT
∞	B30C-500-595-BK	Black	12.70	30.40	1	B30-R10000-WT
∞	B30C-1125-595-BK	Black	29.00	30.40	1	B30-R10000-WT
∞	B30C-2250-595-BK	Black	57.00	30.40	1	B30-R10000-WT
∞	B30C-4000-595-BK	Black	101.00	30.40	1	B30-R10000-WT





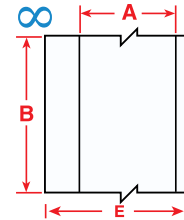
## B-569 high performance polyester

For labelling stainless steel and smooth surfaces

- Recommended for low-halide content for labelling stainless steel pipes and surfaces
- Applies best to very smooth surfaces and ideal for mounting to rigid panels



Diagram	Order Reference	Colour	Width A (mm)	Length B (m)	Labels per Roll	Recommended Ribbon
∞	B30C-500-569-YL	Yellow	12.70	30.40	1	B30-R10000
∞	B30C-1125-569-YL	Yellow	29.00	30.40	1	B30-R10000
∞	B30C-2250-569-YL	Yellow	57.00	30.40	1	B30-R10000
∞	B30C-4000-569-YL	Yellow	101.00	30.40	1	B30-R10000
∞	B30C-500-569-WT	White	12.70	30.40	1	B30-R10000
∞	B30C-1125-569-WT	White	29.00	30.40	1	B30-R10000
∞	B30C-2250-569-WT	White	57.00	30.40	1	B30-R10000
∞	B30C-3000-569-WT	White	75.00	30.40	1	B30-R10000
∞	B30C-4000-569-WT	White	101.00	30.40	1	B30-R10000
∞	B30C-500-569-CL	Transparent	12.70	30.40	1	B30-R10000
∞	B30C-1125-569-CL	Transparent	29.00	30.40	1	B30-R10000
∞	B30C-2250-569-CL	Transparent	57.00	30.40	1	B30-R10000
∞	B30C-4000-569-CL	Transparent	101.00	30.40	1	B30-R10000
∞	B30C-500-569-TN	Tan	12.70	30.40	1	B30-R10000
∞	B30C-1125-569-TN	Tan	29.00	30.40	1	B30-R10000
∞	B30C-2250-569-TN	Tan	57.00	30.40	1	B30-R10000
∞	B30C-4000-569-TN	Tan	101.00	30.40	1	B30-R10000
∞	B30C-500-569-SB	Sky Blue	12.70	30.40	1	B30-R10000
∞	B30C-1125-569-SB	Sky Blue	29.00	30.40	1	B30-R10000
∞	B30C-2250-569-SB	Sky Blue	57.00	30.40	1	B30-R10000
∞	B30C-4000-569-SB	Sky Blue	101.00	30.40	1	B30-R10000
∞	B30C-500-569-RD	Red	12.70	30.40	1	B30-R10000-WT
∞	B30C-1125-569-RD	Red	29.00	30.40	1	B30-R10000-WT
∞	B30C-2250-569-RD	Red	57.00	30.40	1	B30-R10000-WT
∞	B30C-4000-569-RD	Red	101.00	30.40	1	B30-R10000-WT
∞	B30C-500-569-PL	Purple	12.70	30.40	1	B30-R10000-WT
∞	B30C-1125-569-PL	Purple	29.00	30.40	1	B30-R10000-WT
∞	B30C-2250-569-PL	Purple	57.00	30.40	1	B30-R10000-WT
∞	B30C-4000-569-PL	Purple	101.00	30.40	1	B30-R10000-WT
∞	B30C-500-569-PK	Pink	12.70	30.40	1	B30-R10000
∞	B30C-1125-569-PK	Pink	29.00	30.40	1	B30-R10000
∞	B30C-2250-569-PK	Pink	57.00	30.40	1	B30-R10000
∞	B30C-4000-569-PK	Pink	101.00	30.40	1	B30-R10000
∞	B30C-500-569-OR	Orange	12.70	30.40	1	B30-R10000
∞	B30C-1125-569-OR	Orange	29.00	30.40	1	B30-R10000
∞	B30C-2250-569-OR	Orange	57.00	30.40	1	B30-R10000
∞	B30C-4000-569-OR	Orange	101.00	30.40	1	B30-R10000
∞	B30C-500-569-OC	Ochre	12.70	30.40	1	B30-R10000
∞	B30C-1125-569-OC	Ochre	29.00	30.40	1	B30-R10000
∞	B30C-2250-569-OC	Ochre	57.00	30.40	1	B30-R10000
∞	B30C-4000-569-OC	Ochre	101.00	30.40	1	B30-R10000
∞	B30C-500-569-LB	Light Blue	12.70	30.40	1	B30-R10000
∞	B30C-1125-569-LB	Light Blue	29.00	30.40	1	B30-R10000
∞	B30C-2250-569-LB	Light Blue	57.00	30.40	1	B30-R10000
∞	B30C-4000-569-LB	Light Blue	101.00	30.40	1	B30-R10000
∞	B30C-500-569-GY	Grey	12.70	30.40	1	B30-R10000
∞	B30C-1125-569-GY	Grey	29.00	30.40	1	B30-R10000
∞	B30C-2250-569-GY	Grey	57.00	30.40	1	B30-R10000
∞	B30C-4000-569-GY	Grey	101.00	30.40	1	B30-R10000
∞	B30C-500-569-GN	Green	12.70	30.40	1	B30-R10000-WT
∞	B30C-1125-569-GN	Green	29.00	30.40	1	B30-R10000-WT
∞	B30C-2250-569-GN	Green	57.00	30.40	1	B30-R10000-WT
∞	B30C-4000-569-GN	Green	101.00	30.40	1	B30-R10000-WT
∞	B30C-500-569-BR	Brown	12.70	30.40	1	B30-R10000-WT
∞	B30C-1125-569-BR	Brown	29.00	30.40	1	B30-R10000-WT
∞	B30C-2250-569-BR	Brown	57.00	30.40	1	B30-R10000-WT
∞	B30C-4000-569-BR	Brown	101.00	30.40	1	B30-R10000-WT

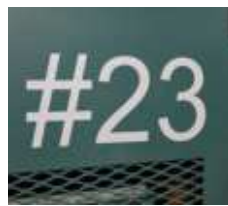
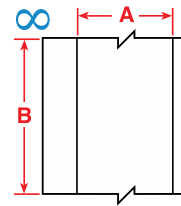


>>



## B-569 high performance polyester (continued)

Diagram	Order Reference	Colour	Width A (mm)	Length B (m)	Labels per Roll	Recommended Ribbon
∞	B30C-500-569-BL	Blue	12.70	30.40	1	B30-R10000-WT
∞	B30C-1125-569-BL	Blue	29.00	30.40	1	B30-R10000-WT
∞	B30C-2250-569-BL	Blue	57.00	30.40	1	B30-R10000-WT
∞	B30C-4000-569-BL	Blue	101.00	30.40	1	B30-R10000-WT
∞	B30C-500-569-BK	Black	12.70	30.40	1	B30-R10000-WT
∞	B30C-1125-569-BK	Black	29.00	30.40	1	B30-R10000-WT
∞	B30C-2250-569-BK	Black	57.00	30.40	1	B30-R10000-WT
∞	B30C-4000-569-BK	Black	101.00	30.40	1	B30-R10000-WT



## Premask application tape

- Use Premask Application Tape to easily apply cut out letters and shapes in a straight line.

Art. No.	Description	Width A (mm)	Length B (m)
243242	PREMASK APPLICATION TAPE	100.00	50.00



## B-595 pre-printed pre-cut blank sign headers

For creating Arc Flash and safety warning labels in seconds

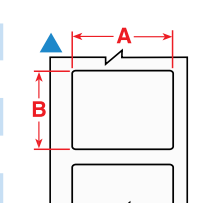
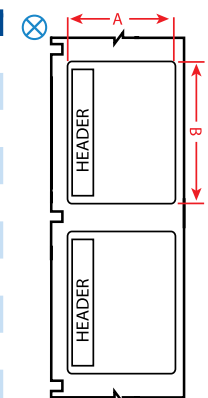
- Allows the printer to create multi-colour signs fast - in a single print pass
- Indoor/Outdoor grade material conforms to rough, irregular and "difficult to adhere to" surfaces



**i** Create Arc Flash labels and safety warning labels by using these supplies with the built-in templates of the BBP35/37 printer or with the templates in the Workstation software.



Diagram	Order Reference		Width A (mm)	Height B (mm)	Labels per Roll	Recommended Ribbon
⊗	B30-25-595-ANSIDA	<b>▲ DANGER</b>	152.40	101.60	175	B30-R10000
⊗	B30-241-595-ANSIDA	<b>▲ DANGER</b>	76.20	57.15	300	B30-R10000
⊗	B30-25-595-ANSICA	<b>▲ CAUTION</b>	152.40	101.60	175	B30-R10000
⊗	B30-241-595-ANSICA	<b>▲ CAUTION</b>	76.20	57.15	300	B30-R10000
⊗	B30-25-595-ANSIWA	<b>▲ WARNING</b>	152.40	101.60	175	B30-R10000
⊗	B30-241-595-ANSIWA	<b>▲ WARNING</b>	76.20	57.15	300	B30-R10000
⊗	B30-25-595-ANSINO	<b>NOTICE</b>	152.40	101.60	175	B30-R10000
⊗	B30-241-595-ANSINO	<b>NOTICE</b>	76.20	57.15	300	B30-R10000
⊗	B30-25-595-OSHADA	<b>▲ DANGER</b>	152.40	101.60	175	B30-R10000
⊗	B30-241-595-OSHADA	<b>▲ DANGER</b>	76.20	57.15	300	B30-R10000
⊗	B30-25-595-OSHACA*	<b>▲ CAUTION</b>	152.40	101.60	175	B30-R10000
⊗	B30-241-595-OSHACA*	<b>▲ CAUTION</b>	76.20	57.15	300	B30-R10000
▲	B30-25-595-BLNKWT		152.40	101.60	175	B30-R10000
▲	B30-241-595-BLNKWT		76.20	57.15	300	B30-R10000
▲	B30-242-595-BLNKWT		72.39	28.58	300	B30-R10000
▲	B30-219-595-BLNKWT		97.80	57.15	250	B30-R10000
▲	B30-25-595-BLNKYL		152.40	101.60	175	B30-R10000
▲	B30-241-595-BLNKYL		76.20	57.15	300	B30-R10000



\*The text area below the header is yellow. Text area below other signs are white  
B30-R10000 coloured ribbons can also be used on these parts

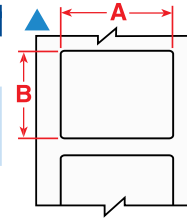
## B-595 pre-printed right-to-know chemical labels

For quickly creating NFPA and Colour Bar labels

- Allows the printer to produce 5 colour chemical labels in a single print pass
- Indoor/Outdoor grade material withstands exposure to moisture, chemicals and handling



Diagram	Order Reference		Width A (mm)	Height B (mm)	Labels per Roll	Recommended Ribbon
	B30-263-595-NFPA		158.75	101.60	170	B30-R10000
	B30-244-595-CB		57.15	57.15	365	B30-R10000
	B30-244-595-NFPA		57.15	57.15	365	B30-R10000
	B30-245-595-CB		101.60	57.15	240	B30-R10000
	B30-245-595-NFPA		101.60	57.15	240	B30-R10000
	B30-244-595-HMIG		57.15	57.15	365	B30-R10000
	B30-246-595-HMIG		76.20	28.58	300	B3w0-R10000
	B30-246-595-NFR		76.20	28.58	300	B30-R10000



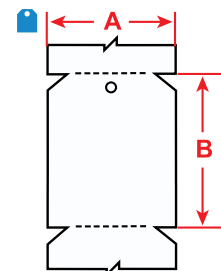
## B-851 non-adhesive pre-printed and pre-cut safety tags

Pre-printed and pre-cut to save you time

- Non-adhesive semi-rigid polyester card stock
- Tags are pre-cut with hole and chamfered corners
- Perforated between tags
- Snap-in plastic grommets available for extra strength around mounting hole. Order reference: 020596



Diagram	Order Reference		Width A (mm)	Height B (mm)	Labels per Roll	Recommended Ribbon
	B30-255-851-OSHA DSB		82.55	146.05	100	B30-R10000
	B30-255-851-ANSI D B		82.55	146.05	100	B30-R10000
	B30-255-851-OSHA D B		82.55	146.05	100	B30-R10000
	B30-255-851-WHT-B		82.55	146.05	100	B30-R10000
	B30-255-851-OSHA D S F		82.55	146.05	100	B30-R10000
	B30-255-851-ANSI D F		82.55	146.05	100	B30-R10000
	B30-255-851-OSHA D F		82.55	146.05	100	B30-R10000
	B30-255-851-WHT-F		82.55	146.05	100	B30-R10000
	B30-255-851-OST-BK		82.55	146.05	100	B30-R10000
	B30-255-851-YLW		82.55	146.05	100	B30-R10000
	B30-255-851-GRN		82.55	146.05	100	B30-R10000
	B30-255-851-RED		82.55	146.05	100	B30-R10000
	B30-255-851-ORNG		82.55	146.05	100	B30-R10000
	B30-255-851-BLUE		82.55	146.05	100	B30-R10000
	B30-255-851-ANSI D A		82.55	146.05	100	B30-R10000
	B30-255-851-OSHA D A		82.55	146.05	100	B30-R10000
	B30-255-851-ANSI C A		82.55	146.05	100	B30-R10000
	B30-255-851-WHT		82.55	146.05	100	B30-R10000





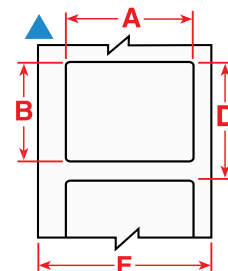
## B-7569 pre-printed GHS/CLP chemical labels

Print 2 colour GHS labels in one fast print pass

- Blank labels with pre-printed red diamonds allow printer to produce 2 colour GHS/CLP labels in one print pass
- 4 sizes of labels that match templates in the Brady Workstation CLP (GHS) app. Find out more at [workstation.bradyd.com](http://workstation.bradyd.com)!
- Indoor/outdoor vinyl material withstands exposure to moisture, chemicals and handling



Diagram	Order Reference		Width A (mm)	Height B (mm)	Labels per Roll	Recommended Ribbon
▲	B30-260-7569-CLP1		55.00	85.00	340	B30-R10000
▲	B30-260-7569-CLP2		55.00	85.00	340	B30-R10000
▲	B30-260-7569-CLP3A		55.00	85.00	340	B30-R10000
▲	B30-260-7569-CLP3B		55.00	85.00	340	B30-R10000
▲	B30-260-7569-CLP4A		55.00	85.00	340	B30-R10000
▲	B30-260-7569-CLP4B		55.00	85.00	340	B30-R10000
▲	B30-261-7569-CLP1		75.00	110.00	270	B30-R10000
▲	B30-261-7569-CLP2		75.00	110.00	270	B30-R10000
▲	B30-261-7569-CLP3A		75.00	110.00	270	B30-R10000
▲	B30-261-7569-CLP3B		75.00	110.00	270	B30-R10000
▲	B30-261-7569-CLP4A		75.00	110.00	270	B30-R10000
▲	B30-261-7569-CLP4B		75.00	110.00	270	B30-R10000
▲	B30-262-7569-CLP1		105.00	155.00	200	B30-R10000
▲	B30-262-7569-CLP2		105.00	155.00	200	B30-R10000
▲	B30-262-7569-CLP3A		105.00	155.00	200	B30-R10000
▲	B30-262-7569-CLP3B		105.00	155.00	200	B30-R10000
▲	B30-262-7569-CLP4A		105.00	155.00	200	B30-R10000
▲	B30-262-7569-CLP4B		105.00	155.00	200	B30-R10000
▲	B30-18-7569-CLP4C		76.20	25.40	1000	B30-R10000



## Brady Workstation CLP (GHS) labels app

Easily design and print GHS/CLP labels using the predefined chemical descriptions, symbols and signal words in the Brady Workstation GHS/CLP label app.

The Brady Workstation GHS/CLP label app enables users to select chemicals by name or CAS-number. The app then automatically populates all required fields to create a compliant GHS/CLP label.



Discover Brady Workstation  
[www.bradyeurope.com/workstation](http://www.bradyeurope.com/workstation)



## B-483/B-634 ToughStripe floor marking tape with overlamine

Ideal for marking aisles, passageways and storage locations

- Create custom-printed floor labels, with easy 3-step process: print label, position on floor, apply overlamine
- Each kit includes 1 roll of B-483 tape and 1 roll of B-634 overlamine

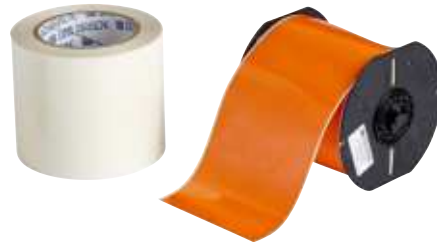
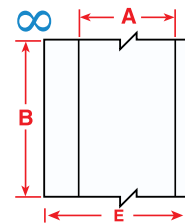


Diagram	Order Reference	Colour	Width A (mm)	Length B (m)	Labels per Roll	Recommended Ribbon
∞	B30C-1125-483BK-KT	Black	29.00	30.40	1	B30-R4400
∞	B30C-2250-483BK-KT	Black	57.00	30.40	1	B30-R4400
∞	B30C-4000-483BK-KT	Black	101.00	30.40	1	B30-R4400
∞	B30C-1125-483BL-KT	Blue	29.00	30.40	1	B30-R4400
∞	B30C-2250-483BL-KT	Blue	57.00	30.40	1	B30-R4400
∞	B30C-4000-483BL-KT	Blue	101.00	30.40	1	B30-R4400
∞	B30C-1125-483GN-KT	Green	29.00	30.40	1	B30-R4400
∞	B30C-2250-483GN-KT	Green	57.00	30.40	1	B30-R4400
∞	B30C-4000-483GN-KT	Green	101.00	30.40	1	B30-R4400
∞	B30C-1125-483OR-KT	Orange	29.00	30.40	1	B30-R6000HF
∞	B30C-2250-483OR-KT	Orange	57.00	30.40	1	B30-R6000HF
∞	B30C-4000-483OR-KT	Orange	101.00	30.40	1	B30-R6000HF
∞	B30C-1125-483RD-KT	Red	29.00	30.40	1	B30-R4400
∞	B30C-2250-483RD-KT	Red	57.00	30.40	1	B30-R4400
∞	B30C-4000-483RD-KT	Red	101.00	30.40	1	B30-R4400
∞	B30C-1125-483WT-KT	White	29.00	30.40	1	B30-R6000HF
∞	B30C-2250-483WT-KT	White	57.00	30.40	1	B30-R6000HF
∞	B30C-3000-483WT-KT	White	75.00	30.40	1	B30-R6000HF
∞	B30C-4000-483WT-KT	White	101.00	30.40	1	B30-R6000HF
∞	B30C-1125-483YL-KT	Yellow	29.00	30.40	1	B30-R6000HF
∞	B30C-2250-483YL-KT	Yellow	57.00	30.40	1	B30-R6000HF
∞	B30C-3000-483YL-KT	Yellow	75.00	30.40	1	B30-R6000HF
∞	B30C-4000-483YL-KT	Yellow	101.00	30.40	1	B30-R6000HF



### ToughStripe floor tape adhesion rates

#### Floor types



Low adhesion

Moderate adhesion

Strong adhesion



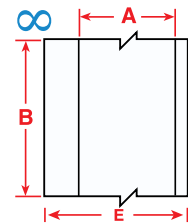
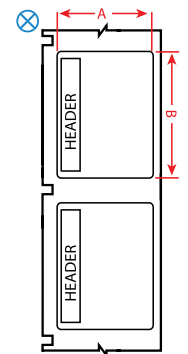
## B-854 and B-855 ToughWash washdown resistant labels

Withstands pressures of high heat, harsh chemicals and numerous washdown cycles

- Ideal for use in the Food & Beverage industry
- Legible and long-lasting for even the toughest washdown cycles
- B-854 offers metal detectable layer to detect foreign debris in food stream



Diagram	Order Reference		Width A (mm)	Height B (mm)	Length B (m)	Labels per Roll	Recommended Ribbon
∞	B30C-1125-855-YL		28.58	-	15.24	1	B30-R6000HF
∞	B30C-1125-855-WT		28.58	-	15.24	1	B30-R6000HF
∞	B30C-2250-855-YL		57.15	-	15.24	1	B30-R6000HF
∞	B30C-2250-855-WT		57.15	-	15.24	1	B30-R6000HF
∞	B30C-4000-855-YL		101.60	-	15.24	1	B30-R6000HF
∞	B30C-4000-855-WT		101.60	-	15.24	1	B30-R6000HF
⊗	B30-25-855-WARN		101.60	152.40	15.24	100	B30-R6000HF
⊗	B30-25-855-DANG		101.60	152.40	15.24	100	B30-R6000HF
⊗	B30-25-855-CAUT		101.60	152.40	15.24	100	B30-R6000HF
∞	B30C-4000-854-YL		101.60	-	15.24	1	B30-R6000HF
∞	B30C-4000-854-WT		101.60	-	15.24	1	B30-R6000HF
⊗	B30-25-854-WARN		101.60	152.40	15.24	100	B30-R6000HF
⊗	B30-25-854-DANG		101.60	152.40	15.24	100	B30-R6000HF
⊗	B30-25-854-CAUT		101.60	152.40	15.24	100	B30-R6000HF



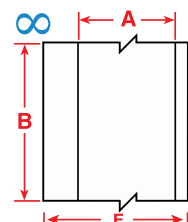
## B-584 retro reflective tape

For highly reflective identification that shines back brightly when struck by light

- Ideal for labelling outdoor utility poles and pedestals, jobsite equipment and roof-top equipment
- Recommended low light or inclement weather conditions



Diagram	Order Reference	Colour	Width A (mm)	Length B (m)	Labels per Roll	Recommended Ribbon
∞	B30C-1125-584-OR	Orange	28.58	15.20	1	B30-R10000
∞	B30C-2250-584-OR	Orange	57.15	15.20	1	B30-R10000
∞	B30C-4000-584-OR	Orange	101.60	15.20	1	B30-R10000
∞	B30C-1125-584-SL	Silver	28.58	15.20	1	B30-R10000
∞	B30C-2250-584-SL	Silver	57.15	15.20	1	B30-R10000
∞	B30C-4000-584-SL	Silver	101.60	15.20	1	B30-R10000
∞	B30C-1125-584-YL	Yellow	28.58	15.20	1	B30-R10000
∞	B30C-2250-584-YL	Yellow	57.15	15.20	1	B30-R10000
∞	B30C-4000-584-YL	Yellow	101.60	15.20	1	B30-R10000



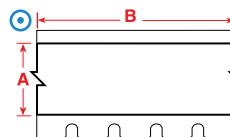
## Continuous tapes for general identification

Allows for efficient material use

- Materials have high-tack adhesives for use onto a wide variety of surfaces and components
- Good for cutting out custom-sized labels



Diagram	Order Reference	Colour	Width A (mm)	Length B (m)	Labels per Row	Labels per Roll	Recommended Ribbon
⊙	B30C-4000-787	White	101.00	18.29	1	1	B30-R6000
⊙	B30C-4000-486	Light Grey	101.00	35.10	1	1	B30-R4300
⊙	B30C-4000-432	Transparent	101.00	36.60	1	1	B30-R6000
⊙	B30C-4000-724	Amber	101.00	39.60	1	1	B30-R4300
⊙	B30C-4000-428	Light Grey	101.00	39.60	1	1	B30-R4300
⊙	B30C-4000-434	Silver	101.00	39.60	1	1	B30-R6000
⊙	B30C-4000-483	White	101.00	39.60	1	1	B30-R6000
⊙	B30C-4000-489	White	101.00	39.60	1	1	B30-R4300
⊙	B30C-4000-488	White	101.00	39.60	1	1	B30-R4300
⊙	B30C-4000-727	White	101.00	39.60	1	1	B30-R6000
⊙	B30C-4000-423	White	101.00	45.70	1	1	B30-R6000
⊙	B30C-4000-437	White	101.00	45.70	1	1	B30-R4300
⊙	B30C-4000-484	White	101.00	45.70	1	1	B30-R6000
⊙	B30C-4000-424	White	101.00	45.70	1	1	B30-R4300



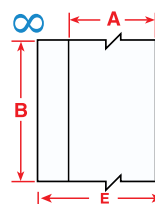
## B-526 BradyGlo high-intensity photoluminescent tape

For glow-in-the-dark identification - up to 10 hours

- Designed for directional and evacuation marking
- Ideal for marking emergency utility shut-offs, fire extinguishers, alarm pulls and vital equipment controls



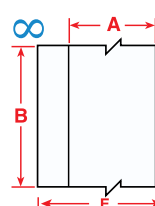
Diagram	Order Reference	Colour	Width A (mm)	Length B (m)	Labels per Roll	Recommended Ribbon
∞	B30C-1125-526	Photoluminescent Green	29.00	15.20	1	B30-R10000
∞	B30C-2250-526	Photoluminescent Green	57.00	15.20	1	B30-R10000
∞	B30C-4000-526	Photoluminescent Green	101.00	15.20	1	B30-R10000



## B-565 high temp metallised polyester tape

- B-565 material has a high upper temperature rating and is not tamper-evident
- Ideal for product rating labels, product warranty labels and asset identification labels

Diagram	Order Reference	Colour	Width A (mm)	Length B (m)	Labels per Roll	Recommended Ribbon
∞	B30C-1125-565-SL	Silver	29.00	30.40	1	B30-R10000
∞	B30C-2250-565-SL	Silver	57.00	30.40	1	B30-R10000
∞	B30C-4000-565-SL	Silver	101.00	30.40	1	B30-R10000



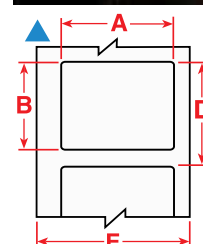
## B-595 and B-7569 pre-cut blank labels

For general purpose, peel-off-and-apply identification

- Ideal for a wide range of labelling applications
- Includes two sizes that are pre-cut and pre-sized to fit heavy-duty rigid tags
- Indoor/Outdoor grade material



Diagram	Order Reference	Colour	Width A (mm)	Height B (mm)	Labels per Roll	Recommended Ribbon
▲	B30-241-7569-YL	Yellow	57.00	75.00	300	B30-R10000
▲	B30-241-595-BLNKYL	Yellow	76.20	57.15	300	B30-R10000
▲	B30-25-7569-YL	Yellow	101.00	152.00	175	B30-R10000
▲	B30-25-595-BLNKYL	Yellow	152.40	101.60	175	B30-R10000
▲	B30-242-7569-WT	White	29.00	72.00	300	B30-R10000
▲	B30-241-7569-WT	White	57.00	75.00	300	B30-R10000
▲	B30-219-7569-WT	White	57.00	98.00	250	B30-R10000
▲	B30-242-595-BLNKWT	White	72.39	28.58	300	B30-R10000
▲	B30-241-595-BLNKWT	White	76.20	57.15	300	B30-R10000
▲	B30-219-595-BLNKWT	White	97.80	57.15	250	B30-R10000
▲	B30-25-7569-WT	White	101.00	152.00	175	B30-R10000
▲	B30-25-595-BLNKWT	White	152.40	101.60	175	B30-R10000





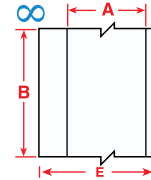
## B-851 non-adhesive tag stock

For safety, lockout and general purpose hanging tags

- Non-adhesive, polyester stock
- Hole punch available separately. Order reference: 020591
- Optional snap-in grommets available. Order Reference: 020596



Diagram	Order Reference	Colour	Width A (mm)	Length B (m)	Height B (mm)	Labels per Roll	Recommended Ribbon
	B30C-2500-551-WT	White	63.50	15.24	-	1	B30-R10000
	B30C-3250-551-WT	White	82.55	15.24	-	1	B30-R10000
	B30C-4250-551-WT	White	107.95	15.24	-	1	B30-R10000



## Coloured nylon ties

Coloured nylon ties provide you with an option of colour coded application.

Order Reference	Art. No.	Colour	Width (mm)	Length (mm)	Packaging
NYTIE-3.6X200-YL	196352	Yellow	3.50	200.00	100
NYTIE-3.6X140-YL	196346	Yellow	3.60	140.00	100
NYTIE-3.5X140-NT	196310	White	3.50	140.00	100
NYTIE-3.5X200-NT	196311	White	3.50	200.00	100
NYTIE-3.6X140-RD	196343	Red	3.60	140.00	100
NYTIE-3.6X200-RD	196351	Red	3.60	200.00	100
NYTIE-3.6X140-GN	196340	Green	3.60	140.00	100
NYTIE-3.6X200-GN	196350	Green	3.60	200.00	100
NYTIE-3.6X140-BL	196337	Blue	3.60	140.00	100
NYTIE-3.6X200-BL	196349	Blue	3.60	200.00	100
NYTIE-3.5X200-BK	196283	Black	3.50	200.00	100



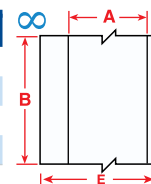
## B-509 printable magnetic supply

Easiest and quickest material for removing and repositioning

- Non-adhesive magnetic material that can be printed on directly
- Ideal for reusable and repositionable identification applications



Diagram	Order Reference	Colour	Width A (mm)	Length B (m)	Labels per Roll	Recommended Ribbon
	B30C-2500-509-YL	Yellow	64.00	7.60	1	B30-R10000
	B30C-4250-509-YL	Yellow	108.00	7.60	1	B30-R10000
	B30C-2500-509-WT	White	64.00	7.60	1	B30-R10000
	B30C-4250-509-WT	White	108.00	7.60	1	B30-R10000



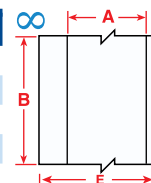
## B-549 cold temperature application material

For identification in temperatures as cold as -40°C

- Special adhesive permanently adheres to extremely cold surfaces
- Ideal for cold storage warehouses, fridges, freezers and short-term outdoor use in winter



Diagram	Order Reference	Colour	Width A (mm)	Length B (m)	Labels per Roll	Recommended Ribbon
	B30C-1125-549-YL	Yellow	29.00	30.40	1	B30-R10000
	B30C-2250-549-YL	Yellow	57.00	30.40	1	B30-R10000
	B30C-4000-549-YL	Yellow	101.00	30.40	1	B30-R10000
	B30C-1125-549-WT	White	29.00	30.40	1	B30-R10000
	B30C-2250-549-WT	White	57.00	30.40	1	B30-R10000
	B30C-4000-549-WT	White	101.00	30.40	1	B30-R10000





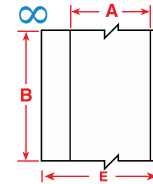
## B-7569 indoor/outdoor vinyl

General purpose industrial vinyl for indoor/outdoor usage

- High gloss, durable and flexible identification material
- Adheres to difficult low surface energy materials
- Can handle up to 75°C, which meets industry maintenance temperatures
- Low-shrink Vinyl

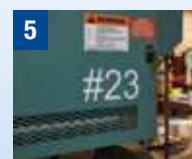
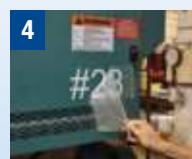


Diagram	Order Reference	Colour	Width A (mm)	Length B (m)	Labels per Roll	Recommended Ribbon
∞	B30C-500-7569-YL	Yellow	12.70	30.00	1	B30-R10000
∞	B30C-1125-7569-YL	Yellow	29.00	30.00	1	B30-R10000
∞	B30C-2250-7569-YL	Yellow	57.00	30.00	1	B30-R10000
∞	B30C-3000-7569-YL	Yellow	75.00	30.00	1	B30-R10000
∞	B30C-4000-7569-YL	Yellow	101.00	30.00	1	B30-R10000
∞	B30C-500-7569-WT	White	12.70	30.00	1	B30-R10000
∞	B30C-1125-7569-WT	White	29.00	30.00	1	B30-R10000
∞	B30C-2250-7569-WT	White	57.00	30.00	1	B30-R10000
∞	B30C-3000-7569-WT	White	75.00	30.00	1	B30-R10000
∞	B30C-4000-7569-WT	White	101.00	30.00	1	B30-R10000
∞	B30C-500-7569-RD	Red	12.70	30.00	1	B30-R10000-WT
∞	B30C-1125-7569-RD	Red	29.00	30.00	1	B30-R10000-WT
∞	B30C-2250-7569-RD	Red	57.00	30.00	1	B30-R10000-WT
∞	B30C-4000-7569-RD	Red	101.00	30.00	1	B30-R10000-WT
∞	B30C-500-7569-OR	Orange	12.70	30.00	1	B30-R10000
∞	B30C-1125-7569-OR	Orange	29.00	30.00	1	B30-R10000
∞	B30C-2250-7569-OR	Orange	57.00	30.00	1	B30-R10000
∞	B30C-4000-7569-OR	Orange	101.00	30.00	1	B30-R10000
∞	B30C-500-7569-GN	Green	12.70	30.00	1	B30-R10000-WT
∞	B30C-1125-7569-GN	Green	29.00	30.00	1	B30-R10000-WT
∞	B30C-2250-7569-GN	Green	57.00	30.00	1	B30-R10000-WT
∞	B30C-4000-7569-GN	Green	101.00	30.00	1	B30-R10000-WT
∞	B30C-500-7569-BL	Blue	12.70	30.00	1	B30-R10000-WT
∞	B30C-1125-7569-BL	Blue	29.00	30.00	1	B30-R10000-WT
∞	B30C-2250-7569-BL	Blue	57.00	30.00	1	B30-R10000-WT
∞	B30C-4000-7569-BL	Blue	101.00	30.00	1	B30-R10000-WT
∞	B30C-500-7569-BK	Black	12.70	30.00	1	B30-R10000-WT
∞	B30C-1125-7569-BK	Black	29.00	30.00	1	B30-R10000-WT
∞	B30C-2250-7569-BK	Black	57.00	30.00	1	B30-R10000-WT
∞	B30C-4000-7569-BK	Black	101.00	30.00	1	B30-R10000-WT



### Transfer tape is the best way to apply cut-out shapes and text!

1. Cut out your shape or text and weed away unneeded material
2. Apply transfer tape over your cut-out objects and press firmly
3. Peel back the transfer tape and expose the adhesive side of your pre-spaced objects
4. Position object in place and press firmly onto final surface
5. Peel back transfer tape at sharp angle to surface
6. Works great for cut-out text on rigid sign panels too.





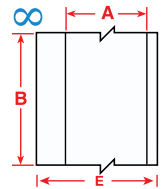
## B-581 repositionable vinyl

For 5S and lean applications

- Aggressive adhesive stays in place but removes cleanly without leaving adhesive residue
- Ideal for temporary, removable and repositionable labels, like 5S and lean inventory labels



Diagram	Order Reference	Colour	Width A (mm)	Length B (m)	Labels per Roll	Recommended Ribbon
∞	B30C-500-581-YL	Yellow	12.50	30.40	1	B30-R10000
∞	B30C-1125-581-YL	Yellow	29.00	30.40	1	B30-R10000
∞	B30C-2250-581-YL	Yellow	57.00	30.40	1	B30-R10000
∞	B30C-4000-581-YL	Yellow	101.00	30.40	1	B30-R10000
∞	B30C-500-581-WT	White	12.50	30.40	1	B30-R10000
∞	B30C-1125-581-WT	White	29.00	30.40	1	B30-R10000
∞	B30C-2250-581-WT	White	57.00	30.40	1	B30-R10000
∞	B30C-4000-581-WT	White	101.00	30.40	1	B30-R10000



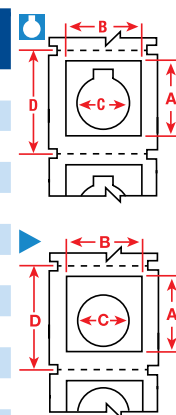
## B-593 raised profile labels - push button style

Lower cost than engraved legend plates

- High gloss, polyester label with thick raised profile and ultra-aggressive adhesive (total thickness = 0.65 mm)
- High performance, low cost substitute to engraved plates
- 10 year outdoor durability rating
- On-demand labelling: labels print out in less than 4 seconds
- 5 push button sizes (including keyed with 22.50 and 30.50 mm hole diam and non-keyed with 22.50 mm hole diam)



Diagram	Order Reference	Colour	Width A (mm)	Height B (mm)	Hole Diameter C (mm)	Vertical Repeat D (mm)	Labels per Roll	Recommended Ribbon
☐	B30EP-167-593-YL	Yellow	30.48	38.10	22.50	44.50	200	B30-R6000HF
▶	B30EP-167U-593-YL	Yellow	30.48	38.10	22.50	44.50	200	B30-R6000HF
☐	B30EP-168-593-YL	Yellow	30.48	48.26	22.50	54.00	180	B30-R6000HF
☐	B30EP-169-593-YL	Yellow	45.72	45.72	30.50	50.80	190	B30-R6000HF
☐	B30EP-170-593-YL	Yellow	60.96	60.96	30.50	66.70	145	B30-R6000HF
☐	B30EP-167-593-WT	White	30.48	38.10	22.50	44.50	200	B30-R6000HF
▶	B30EP-167U-593-WT	White	30.48	38.10	22.50	44.50	200	B30-R6000HF
☐	B30EP-168-593-WT	White	30.48	48.26	22.50	54.00	180	B30-R6000HF
☐	B30EP-169-593-WT	White	45.72	45.72	30.50	50.80	190	B30-R6000HF
☐	B30EP-170-593-WT	White	60.96	60.96	30.50	66.70	145	B30-R6000HF
☐	B30EP-167-593-RD	Red	30.48	38.10	22.50	44.50	200	B30-R4400-WT
▶	B30EP-167U-593-RD	Red	30.48	38.10	22.50	44.50	200	B30-R4400-WT
☐	B30EP-168-593-RD	Red	30.48	48.26	22.50	54.00	180	B30-R4400-WT
☐	B30EP-169-593-RD	Red	45.72	45.72	30.50	50.80	190	B30-R4400-WT
☐	B30EP-170-593-RD	Red	60.96	60.96	30.50	66.70	145	B30-R4400-WT
☐	B30EP-167-593-GN	Green	30.48	38.10	22.50	44.50	200	B30-R4400-WT
▶	B30EP-167U-593-GN	Green	30.48	38.10	22.50	44.50	200	B30-R4400-WT
☐	B30EP-168-593-GN	Green	30.48	48.26	22.50	54.00	180	B30-R4400-WT
☐	B30EP-169-593-GN	Green	45.72	45.72	30.50	50.80	190	B30-R4400-WT
☐	B30EP-170-593-GN	Green	60.96	60.96	30.50	66.70	145	B30-R4400-WT
☐	B30EP-167-593-BK	Black	30.48	38.10	22.50	44.50	200	B30-R4400-WT
▶	B30EP-167U-593-BK	Black	30.48	38.10	22.50	44.50	200	B30-R4400-WT
☐	B30EP-168-593-BK	Black	30.48	48.26	22.50	54.00	180	B30-R4400-WT
☐	B30EP-169-593-BK	Black	45.72	45.72	30.50	50.80	190	B30-R4400-WT
☐	B30EP-170-593-BK	Black	60.96	60.96	30.50	66.70	145	B30-R4400-WT



## B-593 raised profile labels

Lower cost than engraved legend plates

- High gloss, polyester label with thick raised profile and ultra-aggressive adhesive (0.65mm)
- Ideal for inside-panel backer board labels and front-of-enclosure labelling
- On-demand labelling: labels print out in less than 4 seconds
- No need to abbreviate your text to avoid per character engraving charges
- 10-year outdoor durability rating
- 6 colours, 7 rectangular sizes

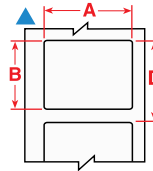


Diagram	Order Reference	Colour	Width A (mm)	Height B (mm)	Vertical Repeat D (mm)	Labels per Roll	Recommended Ribbon
▲	B30EP-171-593-YL	Yellow	26.92	12.45	19.10	500	B30-R6000HF
▲	B30EP-172-593-YL	Yellow	44.99	14.99	21.60	450	B30-R6000HF
▲	B30EP-173-593-YL	Yellow	50.80	25.40	31.80	300	B30-R6000HF
▲	B30EP-175-593-YL	Yellow	76.20	19.05	25.40	375	B30-R6000HF
▲	B30EP-176-593-YL	Yellow	76.20	25.40	31.80	300	B30-R6000HF
▲	B30EP-177-593-YL	Yellow	76.20	63.50	69.90	125	B30-R6000HF
▲	B30EP-174-593-YL	Yellow	101.60	25.40	31.80	300	B30-R6000HF
▲	B30EP-171-593-WT	White	26.92	12.45	19.10	500	B30-R6000HF
▲	B30EP-172-593-WT	White	44.99	14.99	21.60	450	B30-R6000HF
▲	B30EP-173-593-WT	White	50.80	25.40	31.80	300	B30-R6000HF
▲	B30EP-175-593-WT	White	76.20	19.05	25.40	375	B30-R6000HF
▲	B30EP-176-593-WT	White	76.20	25.40	31.80	300	B30-R6000HF
▲	B30EP-177-593-WT	White	76.20	63.50	69.90	125	B30-R6000HF
▲	B30EP-174-593-WT	White	101.60	25.40	31.80	300	B30-R6000HF
▲	B30EP-171-593-SL	Silver	26.92	12.45	19.10	500	B30-R6000HF
▲	B30EP-172-593-SL	Silver	44.99	14.99	21.60	450	B30-R6000HF
▲	B30EP-173-593-SL	Silver	50.80	25.40	31.80	300	B30-R6000HF
▲	B30EP-174-593-SL	Silver	101.60	25.40	31.80	300	B30-R6000HF
▲	B30EP-171-593-RD	Red	26.92	12.45	19.10	500	B30-R4400-WT
▲	B30EP-172-593-RD	Red	44.99	14.99	21.60	450	B30-R4400-WT
▲	B30EP-173-593-RD	Red	50.80	25.40	31.80	300	B30-R4400-WT
▲	B30EP-174-593-RD	Red	101.60	25.40	31.80	300	B30-R4400-WT
▲	B30EP-171-593-GN	Green	26.92	12.45	19.10	500	B30-R4400-WT
▲	B30EP-172-593-GN	Green	44.99	14.99	21.60	450	B30-R4400-WT
▲	B30EP-173-593-GN	Green	50.80	25.40	31.80	300	B30-R4400-WT
▲	B30EP-175-593-GN	Green	76.20	19.05	25.40	375	B30-R4400-WT
▲	B30EP-176-593-GN	Green	76.20	25.40	31.80	300	B30-R4400-WT
▲	B30EP-177-593-GN	Green	76.20	63.50	69.90	125	B30-R4400-WT
▲	B30EP-174-593-GN	Green	101.60	25.40	31.80	300	B30-R4400-WT
▲	B30EP-171-593-BK	Black	26.92	12.45	19.10	500	B30-R4400-WT
▲	B30EP-172-593-BK	Black	44.99	14.99	21.60	450	B30-R4400-WT
▲	B30EP-173-593-BK	Black	50.80	25.40	31.80	300	B30-R4400-WT
▲	B30EP-175-593-BK	Black	76.20	19.05	25.40	375	B30-R4400-WT
▲	B30EP-176-593-BK	Black	76.20	25.40	31.80	300	B30-R4400-WT
▲	B30EP-177-593-BK	Black	76.20	63.50	69.90	125	B30-R4400-WT
▲	B30EP-174-593-BK	Black	101.60	25.40	31.80	300	B30-R4400-WT



## Print ribbons

“Drop & Click” Print Ribbons for Quick and Easy Supply Changes

- Tough, smear-proof ribbons that produce long-lasting printed text
- Print can withstand years in industrial areas and outdoor conditions
- Ribbons supplied in self-contained cartridges that drop straight into the printer with a “click”
- No calibrating, no threading, no waste, no hassle and the ink will always be facing the right direction
- Printer notifies user if installed ribbon is not recommended for the installed labels



All multi-colour panelled and process colour ribbons are compatible with BBP35 & BBP37 only.

Order Reference	Colour	Width (mm) x Length (m)
B30-R10000-BL	Blue	110 mm x 60.90 m
B30-R10000-GN	Green	110 mm x 60.90 m
B30-R10000-OR	Orange	110 mm x 60.90 m
B30-R10000-RD	Red	110 mm x 60.90 m
B30-R10000-YL**	Yellow	110 mm x 60.90 m
B30-R10000-YL2**	Yellow	110 mm x 60.90 m
B30-R10000	Black	110 mm x 60.90 m
B30-R60000C***	Black	110 mm x 60.90 m
B30-R6000HF	Black	110 mm x 60.90 m
B30-R4300	Black	110 mm x 60.90 m
B30-R6600	Black	110 mm x 60.90 m
B30-R6200	Black	110 mm x 60.90 m
B30-R10000-WT	White	110 mm x 60.90 m
B30-R4400-WT	White	110 mm x 60.90 m

Order Reference	Colour	Width (mm) x Length (m)
B30-R6700-WT	White	110 mm x 60.90 m
B30-R10000-KO-8*	Black & Orange	110 mm x 60.90 m
B30-R10000-KO-16*	Black & Orange	110 mm x 60.90 m
B30-R10000-KB-8*	Black & Blue	110 mm x 60.90 m
B30-R10000-KB-16*	Black & Blue	110 mm x 60.90 m
B30-R10000-KR-8*	Black & Red	110 mm x 60.90 m
B30-R10000-KR-16*	Black & Red	110 mm x 60.90 m
B30-R10000-RB-16*	Red & Blue	110 mm x 60.90 m
B30-R10000-GR-8*	Green & Red	110 mm x 60.90 m
B30-R10000-KRYB-8*	Black, Red, Yellow, Blue	110 mm x 60.90 m
B30-R10000-KRYB-16*	Black, Red, Yellow, Blue	110 mm x 60.90 m
B30-R10000-KRYG-8*	Black, Red, Yellow, Green	110 mm x 60.90 m

\* '-8' have 200mm colour panels; those ending in '-16' have 400mm colour panels.

\*\* For printing yellow onto white B-595 use B30-R10000-YL. For printing yellow onto other colours of B-595 use B30-R10000-YL2.

\*\*\*Black Heavy-Duty Print Ribbon to print Ochre B-595 on BBP3x Printers

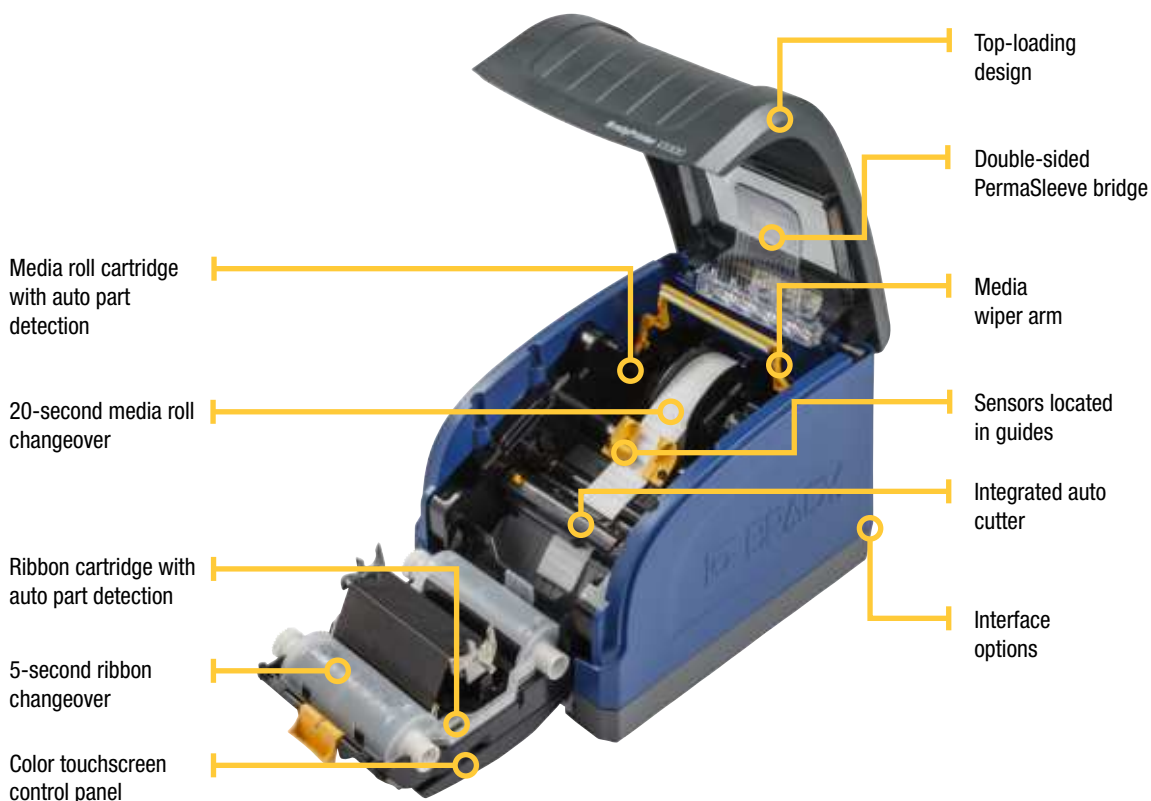
## i3300, S3100, S3700 print ribbon/material compatibility

B Number	B30-R10000 Black	B30-R10000-WT White	B30-R10000 Colours	B30-R10000-YL2** Yellow	B30-R4400-WT White	B30-R60000C Black	B30-R6000HF Black
B-483/B-634					✓		✓
B-509	✓		✓				✓
B-526	✓		✓				✓
B-549	✓	✓	✓				
B-551	✓		✓				✓
B-569	✓	✓	✓				✓
B-581	✓	✓	✓				✓
B-584	✓		✓				✓
B-593					✓		✓
B-595	✓	✓	✓	✓		✓	✓
B-851	✓		✓				
B-854							✓
B-855							✓
B-7569	✓	✓	✓				✓

\*\* For printing yellow onto white B-595 use B30-R10000-YL. For printing yellow onto other colours of B-595 use B30-R10000-YL2



# i3300/S3100 at a glance



Watch the how to videos on our Brady YouTube channel.



# S3700 at a glance



Learn more at [bradyeurope.com/S3700](http://bradyeurope.com/S3700) or scan to watch the overview video



## BBP85 Sign & Label Printer

- 44-45 BBP85 Sign & Label Printer
- 45 BLS laminating system and panels
- 45 Safety sliders consumable kit
- 46 B-595 high performance indoor/outdoor vinyl
- 47 B-595 pre-printed right-to-know chemical labels
- 47 B-595 pre-printed pre-cut blank sign headers
- 48 B-7569 indoor/outdoor vinyl
- 48 B-7569 pre-printed GHS/CLP chemical labels
- 49 B-7569 pre-printed pre-cut blank sign headers
- 49 B-569 high performance polyester
- 50 B-584 retro reflective tape
- 50 B-526 BradyGlo high-intensity photoluminescent tape
- 51 BBP85 print ribbons
- 52 BBP85 at a glance







## BBP85 SIGN & LABEL PRINTER

The BBP85 Sign and Label Printer allows you to create 254 mm wide labels in multiple colours, and it has an easier-than-ever interface that anyone on your team can use! No more complex, tedious design steps. No more ordering and waiting. Now you can just walk up and print... and instantly create high quality, multi-coloured visuals up to 254 mm wide.

### Big output. Little fuss.

Create extra-large custom signs and labels right now! This printer has our fastest, easiest operating system, so anyone on your team can design visuals with little to no training. The ideal printer for multi-user Lean, 5S and Kaizen Labelling events!

### Bold multi-colour printing.

Get your message noticed with strong, colourful visuals. Print up to 4 colours on a single label for professional-looking, custom-made signs, labels and warnings that demand attention.



- Unmistakably large visuals up to 254 mm wide
- Just walk up and print...it really is that easy!
- Simple touch-screen interface for stand-alone use, or print from your PC with MarkWare Software
- Timesaving label design apps to create pipe markers, safety signs, right-to-know labels and more!
- USB port for importing files, fonts and graphics



- Highly durable multi-colour thermal transfer printing
- Print common sign formats even faster using pre-printed sign header supplies
- Add more label creation flexibility with Brady Workstation signs creation apps
- Ethernet port for easy printer networking



Multi-colour signs



Reflective signs



Photoluminescent signs



Pipe markers



Warehouse identification



Hazard warning signs



## Best-of-the-best materials.

Brady's sign and label materials lead the industry in durability and performance.

They withstand harsh conditions, stay stuck on the most challenging surfaces and they simply last longer than other materials on the market. With the BBP85 Sign and Label Printer, you can choose from over one hundred supply options, including:



- Huge selection of 101.60 mm wide to 254 mm wide industrial grade outdoor materials
- Specialty materials including Reflective and Glow-in-the-Dark
- Pre-printed sign header supplies for CLP (GHS) and OSHA or ANSI safety signs, which means only one print pass!

## BBP85 printer

Order Reference	Art. No.	Description
BBP85-AM	132741	BBP85 Sign and Label Printer QWERTY US
BBP85-AZ-SFIDS	198566	BBP85 Sign & Label Printer - AZERTY with Brady Workstation SFID Suite
BBP85-CYR-SFIDS	198567	BBP85 Sign & Label Printer - CYRILLIC with Brady Workstation SFID Suite
BBP85-QY-EU-SFIDS	198568	BBP85 Sign & Label Printer - QWERTY EU with Brady Workstation SFID Suite
BBP85-QY-US-SFIDS	198569	BBP85 Sign & Label Printer - QWERTY US with Brady Workstation SFID Suite
BBP85-QY-UK-SFIDS	198570	BBP85 Sign & Label Printer - QWERTY UK with Brady Workstation SFID Suite
BBP85-QZ-SFIDS	198571	BBP85 Sign & Label Printer - QWERTZ with Brady Workstation SFID Suite
BBP85-AZ	198689	BBP85 Sign and Label Printer AZERTY
BBP85-CYR	198690	BBP85 Sign and Label Printer CYRILLIC
BBP85-QY-EU	198691	BBP85 Sign and Label Printer QWERTY EU
BBP85-QY-UK	198693	BBP85 Sign and Label Printer QWERTY UK
BBP85-QZ	198694	BBP85 Sign and Label Printer QWERTZ



The Basic Suite is included with every printer, download it: [WorkStation.BradyID.com/Free](http://WorkStation.BradyID.com/Free)



Create custom signs, labels and pipemarkers with [WorkStation.BradyID.com/SFID](http://WorkStation.BradyID.com/SFID)

## BBP85 accessories

Order Reference	Art. No.	Description
CLEANING PEN	064692	Cleaning Pen for DIY systems
B85-DC	134001	BBP85 Dust Cover
BBP85 TROLLEY	134428	BBP85 Trolley
142115	142115	Replacement Stylus 3 Pack
NET-BT	142265	Bluetooth Network Card
NET-LAN	142267	LAN Network Card
NET-WIFI-LAN	142268	WIFI/ LAN Network Card
CLEANING KIT	266116	Cleaning Kit



## BLS laminating system and panels

Brady's BLS2000 laminating system quickly mounts printed signs to acrylic panels.

Offers rigidity and protection for signs affected by external factors such as acid spills, solvents, etc. The end result makes the signs look even more professional, allowing the panel to be mounted to, or suspended from the structure of your choice.

Art. No.	Description
013506	BLS 2000 Laminating System
013400	Clear Acrylic Semi-Rigid Panel 100 mm x 152 mm
013401	Clear Acrylic Semi-Rigid Panel 203 mm x 203 mm
013403	Clear Acrylic Semi-Rigid Panel 254 mm x 177 mm
013402	Clear Acrylic Semi-Rigid Panel 254 mm x 254 mm
013404	Clear Acrylic Semi-Rigid Panel 254 mm x 355 mm
013405	Clear Acrylic Semi-Rigid Panel 254 mm x 760 mm



## Safety sliders consumable kit

Print these blank rigid boards for use in Brady's flexible Safety Slider facility communication system.



Order Reference	Description
B85-RIGID SIGN-KIT	Rigid signs panel kit for BBP85 Printer

This kit includes one each of the following parts:

Order Reference	Description	Colour	Size - Width A (mm)	Size - Height B (mm)	Size - Length B (m)	Labels per Roll
B85-R-158x60-BK	Ribbon(s)	Black	158.00	-	60.00	1
B85-R-158x60-RD	Ribbon(s)	Red	158.00	-	60.00	1
B85-R-158x60-BL	Ribbon(s)	Blue	158.00	-	60.00	1
B85-R-158x60-GN	Ribbon(s)	Green	158.00	-	60.00	1
B85-R-158x60-YL	Ribbon(s)	Yellow	158.00	-	60.00	1
B85-150x15M-7569WT	Roll(s)	White	150.00	-	15.00	1
SLIDER BOARD-PVC-450x850mm-BLANK-LS	Sign(s)	White	450.00	830.00	-	1
SLIDER INSERT-PP-450x150mm-BLANK	Sign(s)	White	450.00	150.00	-	1

Compatible with BBP85 printer.



## B-595 high performance indoor/outdoor vinyl

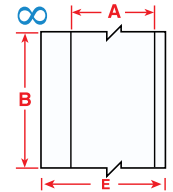
For general facility and safety identification: our best industrial vinyl yet

- Durable, low-shrink vinyl with our most aggressive adhesive
- Conforms to irregular, curved, rough and highly textured surfaces (painted cinder blocks, uneven wood, textured plastics, paper-jacketed pipes, powder-coated surfaces)
- Adheres to “difficult” low-surface energy items (PVC piping, blow-moulded equipment cases, ABS plastics, recycled plastics)



**Safety and facility identification:** 5S labels, pipe markers, safety & warning labels, equipment & panel labels, arc flash & chemical labels and more!

Diagram	Order Reference	Colour	Width A (mm)	Length B (m)	Labels per Roll	Recommended Ribbon
∞	B85-100x15M-595-YL	Yellow	100.00	15.00	1	B85-R-158x60-BK
∞	B85-150x15M-595-YL	Yellow	150.00	15.00	1	B85-R-158x60-BK
∞	B85-178x15M-595-YL	Yellow	178.00	15.00	1	B85-R-220x60-BK
∞	B85-200x15M-595-YL	Yellow	200.00	15.00	1	B85-R-220x60-BK
∞	B85-250x15M-595-YL	Yellow	250.00	15.00	1	B85-R-220x60-BK
∞	B85-100x15M-595-WT	White	100.00	15.00	1	B85-R-158x60-BK
∞	B85-150x15M-595-WT	White	150.00	15.00	1	B85-R-158x60-BK
∞	B85-178x15M-595-WT	White	178.00	15.00	1	B85-R-220x60-BK
∞	B85-200x15M-595-WT	White	200.00	15.00	1	B85-R-220x60-BK
∞	B85-250x15M-595-WT	White	250.00	15.00	1	B85-R-220x60-BK
∞	B85-100x15M-595-CL	Transparent	100.00	15.00	1	B85-R-158x60-BK
∞	B85-150x15M-595-CL	Transparent	150.00	15.00	1	B85-R-158x60-BK
∞	B85-200x15M-595-CL	Transparent	200.00	15.00	1	B85-R-220x60-BK
∞	B85-250x15M-595-CL	Transparent	250.00	15.00	1	B85-R-220x60-BK
∞	B85-100x15M-595-RD	Red	100.00	15.00	1	B85-R-158x60-BK
∞	B85-150x15M-595-RD	Red	150.00	15.00	1	B85-R-158x60-WT
∞	B85-178x15M-595-RD	Red	178.00	15.00	1	B85-R-220x60-WT
∞	B85-200x15M-595-RD	Red	200.00	15.00	1	B85-R-220x60-BK
∞	B85-250x15M-595-RD	Red	250.00	15.00	1	B85-R-220x60-WT
∞	B85-100x15M-595-PL	Purple	100.00	15.00	1	B85-R-158x60-WT
∞	B85-150x15M-595-PL	Purple	150.00	15.00	1	B85-R-158x60-WT
∞	B85-200x15M-595-PL	Purple	200.00	15.00	1	B85-R-220x60-BK
∞	B85-250x15M-595-PL	Purple	250.00	15.00	1	B85-R-220x60-WT
∞	B85-100x15M-595-OR	Orange	100.00	15.00	1	B85-R-158x60-BK
∞	B85-150x15M-595-OR	Orange	150.00	15.00	1	B85-R-158x60-BK
∞	B85-178x15M-595-OR	Orange	178.00	15.00	1	B85-R-220x60-BK
∞	B85-200x15M-595-OR	Orange	200.00	15.00	1	B85-R-220x60-BK
∞	B85-250x15M-595-OR	Orange	250.00	15.00	1	B85-R-220x60-BK
∞	B85-100x15M-595-GY	Grey	100.00	15.00	1	B85-R-158x60-BK
∞	B85-150x15M-595-GY	Grey	150.00	15.00	1	B85-R-158x60-BK
∞	B85-200x15M-595-GY	Grey	200.00	15.00	1	B85-R-220x60-BK
∞	B85-250x15M-595-GY	Grey	250.00	15.00	1	B85-R-220x60-BK
∞	B85-100x15M-595-GN	Green	100.00	15.00	1	B85-R-158x60-BK
∞	B85-150x15M-595-GN	Green	150.00	15.00	1	B85-R-158x60-WT
∞	B85-178x15M-595-GN	Green	178.00	15.00	1	B85-R-220x60-WT
∞	B85-200x15M-595-GN	Green	200.00	15.00	1	B85-R-220x60-BK
∞	B85-250x15M-595-GN	Green	250.00	15.00	1	B85-R-220x60-WT
∞	B85-100x15M-595-GD	Gold	100.00	15.00	1	B85-R-158x60-BK
∞	B85-150x15M-595-GD	Gold	150.00	15.00	1	B85-R-158x60-BK
∞	B85-200x15M-595-GD	Gold	200.00	15.00	1	B85-R-220x60-BK
∞	B85-250x15M-595-GD	Gold	250.00	15.00	1	B85-R-220x60-BK
∞	B85-100x15M-595-BR	Brown	100.00	15.00	1	B85-R-158x60-WT
∞	B85-150x15M-595-BR	Brown	150.00	15.00	1	B85-R-158x60-WT
∞	B85-200x15M-595-BR	Brown	200.00	15.00	1	B85-R-220x60-BK
∞	B85-250x15M-595-BR	Brown	250.00	15.00	1	B85-R-220x60-WT
∞	B85-100x15M-595-BL	Blue	100.00	15.00	1	B85-R-158x60-BK
∞	B85-150x15M-595-BL	Blue	150.00	15.00	1	B85-R-158x60-WT
∞	B85-178x15M-595-BL	Blue	178.00	15.00	1	B85-R-220x60-WT
∞	B85-200x15M-595-BL	Blue	200.00	15.00	1	B85-R-220x60-BK
∞	B85-250x15M-595-BL	Blue	250.00	15.00	1	B85-R-220x60-WT
∞	B85-100x15M-595-BK	Black	100.00	15.00	1	B85-R-158x60-WT
∞	B85-150x15M-595-BK	Black	150.00	15.00	1	B85-R-158x60-WT
∞	B85-200x15M-595-BK	Black	200.00	15.00	1	B85-R-220x60-BK
∞	B85-250x15M-595-BK	Black	250.00	15.00	1	B85-R-220x60-WT



U.S. Patent Nos.  
5,318,370;  
5,823,689;  
6,570,602.  
Additional Patents  
Pending.

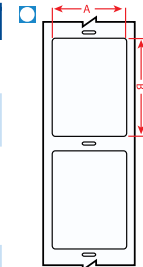
## B-595 pre-printed right-to-know chemical labels

For quickly creating NFPA and Colour Bar labels

- Allows the printer to produce 5 colour chemical labels in a single print pass
- Indoor/Outdoor grade material withstands exposure to moisture, chemicals and handling



Diagram	Order Reference		Width A (mm)	Height B (mm)	Labels per Roll	Recommended Ribbon
	B85-102x152-595-NFPADIA		152.40	101.60	95	R6000 Halogen Free, R6000
	B85-178x254-595-NFPADIA		254.00	177.80	60	R6000 Halogen Free, R6000
	B85-152x152-595-NFPA		152.00	152.40	95	R6000 Halogen Free, R6000
	B85-102x152-595-COLOURBAR		152.40	101.60	95	R6000 Halogen Free, R6000
	B85-178x254-595-COLOURBAR		254.00	177.80	60	R6000 Halogen Free, R6000



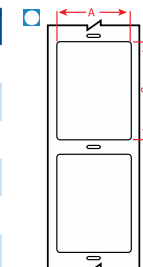
## B-595 pre-printed pre-cut blank sign headers

For creating safety warning labels in seconds.

- Allows the printer to create multi-colour signs fast - in a single print pass
- Headers meet OSHA 1910.145 and ASME/ANSI Z535 standards
- Indoor/Outdoor grade material conforms to rough, irregular and "difficult to adhere to" surfaces



Diagram	Order Reference		Width A (mm)	Height B (mm)	Labels per Roll	Recommended Ribbon
	B85-102x152-595-ANSICA		152.40	101.60	95	R6000 Halogen Free, R6000
	B85-178x254-595-ANSICA		254.00	177.80	60	R6000 Halogen Free, R6000
	B85-102x152-595-ANSIDA		152.40	101.60	95	R6000 Halogen Free, R6000
	B85-178x254-595-ANSIDA		254.00	177.80	60	R6000 Halogen Free, R6000
	B85-102x152-595-ANSINO		152.40	101.60	95	R6000 Halogen Free, R6000
	B85-178x254-595-ANSINO		254.00	177.80	60	R6000 Halogen Free, R6000
	B85-102x152-595-ANSIWA		152.40	101.60	95	R6000 Halogen Free, R6000
	B85-178x254-595-ANSIWA		254.00	177.80	60	R6000 Halogen Free, R6000
	B85-102x152-595-OSHACA		152.40	101.60	95	R6000 Halogen Free, R6000
	B85-178x254-595-OSHACA		254.00	177.80	60	R6000 Halogen Free, R6000
	B85-102x152-595-OSHADA		152.40	101.60	95	R6000 Halogen Free, R6000
	B85-178x254-595-OSHADA		254.00	177.80	60	R6000 Halogen Free, R6000
	B85-178x254-595-WT		254.00	177.80	60	R6000 Halogen Free, R6000
	B85-178x254-595-YL		254.00	177.80	60	R6000 Halogen Free, R6000



### Which material for which application?

For more information on which printer material is suitable for a particular application, please refer to our guide located on page 9.



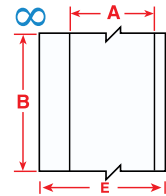
## B-7569 indoor/outdoor vinyl

General purpose industrial vinyl for indoor/outdoor usage

- High gloss, durable and flexible identification material
- Adheres to difficult low surface energy materials
- Can handle up to 75°C, which meets industry maintenance temperatures
- Low-shrink Vinyl



Diagram	Order Reference	Colour	Width A (mm)	Length B (m)	Labels per Roll	Recommended Ribbon
∞	B85-100x15M-7569YL	Yellow	100.00	15.00	1	B85-R-158x60-BK
∞	B85-150x15M-7569YL	Yellow	150.00	15.00	1	B85-R-158x60-BK
∞	B85-200x15M-7569YL	Yellow	200.00	15.00	1	B85-R-220x60-BK
∞	B85-250x15M-7569YL	Yellow	250.00	15.00	1	B85-R-220x60-BK
∞	B85-100x15M-7569WT	White	100.00	15.00	1	B85-R-158x60-BK
∞	B85-150x15M-7569WT	White	150.00	15.00	1	B85-R-158x60-BK
∞	B85-200x15M-7569WT	White	200.00	15.00	1	B85-R-220x60-BK
∞	B85-250x15M-7569WT	White	250.00	15.00	1	B85-R-220x60-BK
∞	B85-100x15M-7569RD	Red	100.00	15.00	1	B85-R-158x60-WT
∞	B85-200x15M-7569RD	Red	200.00	15.00	1	B85-R-220x60-WT
∞	B85-250x15M-7569RD	Red	250.00	15.00	1	B85-R-220x60-WT
∞	B85-250x15M-7569OR	Orange	250.00	15.00	1	B85-R-220x60-BK
∞	B85-100x15M-7569GN	Green	100.00	15.00	1	B85-R-158x60-WT
∞	B85-200x15M-7569GN	Green	200.00	15.00	1	B85-R-220x60-WT
∞	B85-250x15M-7569GN	Green	250.00	15.00	1	B85-R-220x60-WT
∞	B85-100x15M-7569BL	Blue	100.00	15.00	1	B85-R-158x60-WT
∞	B85-200x15M-7569BL	Blue	200.00	15.00	1	B85-R-220x60-WT
∞	B85-250x15M-7569BL	Blue	250.00	15.00	1	B85-R-220x60-WT
∞	B85-100x15M-7569BK	Black	100.00	15.00	1	B85-R-158x60-WT
∞	B85-250x15M-7569BK	Black	250.00	15.00	1	B85-R-220x60-WT



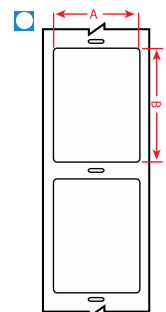
## B-7569 pre-printed CLP (GHS) chemical labels

Print 2 colour CLP (GHS) labels in one fast print pass!

- Blank labels with pre-printed red diamonds allow printer to produce 2 colour CLP (GHS) labels in one print pass
- 3 sizes of labels, each with 6 diamond layouts that match templates in the Brady Workstation CLP (GHS) app. Find out more at [workstation.bradyid.com](http://workstation.bradyid.com)!
- Indoor/outdoor vinyl material withstands exposure to moisture, chemicals and handling



Diagram	Order Reference	Width A (mm)	Height B (mm)	Labels per Roll	Recommended Ribbon
□	B85-105x155-7569-CLP1	154.94	104.14	90	B85-R-158x60-BK
□	B85-105x155-7569-CLP2	154.94	104.14	90	B85-R-158x60-BK
□	B85-105x155-7569-CLP3A	154.94	104.14	90	B85-R-158x60-BK
□	B85-105x155-7569-CLP3B	154.94	104.14	90	B85-R-158x60-BK
□	B85-105x155-7569-CLP4A	154.94	104.14	90	B85-R-158x60-BK
□	B85-105x155-7569-CLP4B	154.94	104.14	90	B85-R-158x60-BK
□	B85-155x210-7569-CLP1	210.82	154.90	70	B85-R-158x60-BK
□	B85-155x210-7569-CLP2	210.82	154.90	70	B85-R-158x60-BK
□	B85-155x210-7569-CLP3A	210.82	154.90	70	B85-R-158x60-BK
□	B85-155x210-7569-CLP3B	210.82	154.90	70	B85-R-158x60-BK
□	B85-155x210-7569-CLP4A	210.82	154.90	70	B85-R-158x60-BK
□	B85-155x210-7569-CLP4B	210.82	154.90	70	B85-R-158x60-BK





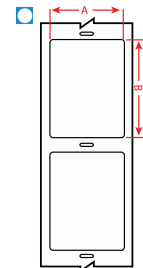
## B-7569 pre-printed pre-cut blank sign headers

For creating safety warning labels in seconds.

- Allows the printer to create multi-colour signs fast - in a single print pass
- Headers meet OSHA 1910.145 and ASME/ANSI Z535 standards
- High gloss, durable and flexible identification material
- Adheres to difficult low surface energy materials
- Can handle up to 75°C, which meets industry maintenance temperatures
- Low-shrink Vinyl



Diagram	Order Reference		Width A (mm)	Height B (mm)	Labels per Roll	Recommended Ribbon
	B85-254x356-7569-WT		356.00	25.40	40	B85-R-220x60-BK
	B85-254x356-7569-YL		356.00	25.40	40	B85-R-220x60-BK
	B85-254x356-7569-OSHACA		356.00	25.40	40	B85-R-220x60-BK
	B85-254x356-7569-ANSICA		356.00	25.40	40	B85-R-220x60-BK
	B85-254x356-7569-ANSIDA		356.00	25.40	40	B85-R-220x60-BK
	B85-254x356-7569-ANSINO		356.00	25.40	40	B85-R-220x60-BK
	B85-254x356-7569-ANSIWA		356.00	25.40	40	B85-R-220x60-BK
	B85-254x356-7569-OSHADA		356.00	25.40	40	B85-R-220x60-BK



## B-569 high performance polyester

For labelling stainless steel and smooth surfaces

- Recommended for low-halide content for labelling stainless steel pipes and surfaces
- Applies best to very smooth surfaces and ideal for mounting to rigid panels

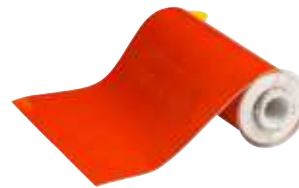
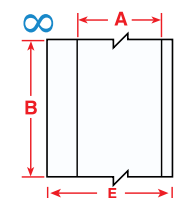


Diagram	Order Reference	Colour	Width A (mm)	Length B (m)	Labels per Roll	Recommended Ribbon
	B85-100x15M-569-LB	Light Blue	100.00	15.00	1	B85-R-158x60-BK
	B85-150x15M-569-LB	Light Blue	150.00	15.00	1	B85-R-158x60-BK
	B85-178x15M-569-LB	Light Blue	178.00	15.00	1	B85-R-220x60-BK
	B85-250x15M-569-LB	Light Blue	250.00	15.00	1	B85-R-220x60-BK
	B85-100x15M-569-OC	Ochre	100.00	15.00	1	B85-R-158x60-BK
	B85-150x15M-569-OC	Ochre	150.00	15.00	1	B85-R-158x60-BK
	B85-178x15M-569-OC	Ochre	178.00	15.00	1	B85-R-220x60-BK
	B85-250x15M-569-OC	Ochre	250.00	15.00	1	B85-R-220x60-BK
	B85-100x15M-569-OR	Orange	100.00	15.00	1	B85-R-158x60-BK
	B85-150x15M-569-OR	Orange	150.00	15.00	1	B85-R-158x60-BK
	B85-178x15M-569-OR	Orange	178.00	15.00	1	B85-R-220x60-BK
	B85-250x15M-569-OR	Orange	250.00	15.00	1	B85-R-220x60-BK
	B85-250x15M-569-PK	Pink	250.00	15.00	1	B85-R-220x60-BK
	B85-100x15M-569-CL	Transparent	100.00	15.00	1	B85-R-158x60-BK
	B85-150x15M-569-CL	Transparent	150.00	15.00	1	B85-R-158x60-BK
	B85-178x15M-569-CL	Transparent	178.00	15.00	1	B85-R-220x60-BK
	B85-250x15M-569-CL	Transparent	250.00	15.00	1	B85-R-220x60-BK
	B85-100x15M-569-WT	White	100.00	15.00	1	B85-R-158x60-BK
	B85-150x15M-569-WT	White	150.00	15.00	1	B85-R-158x60-BK
	B85-178x15M-569-WT	White	178.00	15.00	1	B85-R-220x60-BK
	B85-250x15M-569-WT	White	250.00	15.00	1	B85-R-220x60-BK
	B85-100x15M-569-YL	Yellow	100.00	15.00	1	B85-R-158x60-BK
	B85-150x15M-569-YL	Yellow	150.00	15.00	1	B85-R-158x60-BK
	B85-178x15M-569-YL	Yellow	178.00	15.00	1	B85-R-220x60-BK
	B85-250x15M-569-YL	Yellow	250.00	15.00	1	B85-R-220x60-BK





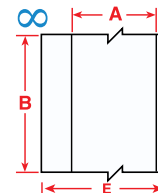
## B-584 retro reflective tape

For highly reflective identification that shines back brightly when struck by light

- Ideal for labelling outdoor utility poles and pedestals, jobsite equipment and roof-top equipment
- Recommended low light or inclement weather conditions
- Class 1 Reflectivity (Fed. Spec. L-S-300)



Diagram	Order Reference	Colour	Width A (mm)	Length B (m)	Labels per Roll	Recommended Ribbon
∞	B85-100x10M-584-OR	Orange	100.00	10.00	1	B85-R-158x60-BK
∞	B85-178x10M-584-OR	Orange	178.00	10.00	1	B85-R-220x60-BK
∞	B85-250x10M-584-OR	Orange	250.00	10.00	1	B85-R-220x60-BK
∞	B85-100x10M-584-SV	Silver	100.00	10.00	1	B85-R-158x60-BK
∞	B85-178x10M-584-SV	Silver	178.00	10.00	1	B85-R-220x60-BK
∞	B85-250x10M-584-SV	Silver	250.00	10.00	1	B85-R-220x60-BK
∞	B85-100x10M-584-YL	Yellow	100.00	10.00	1	B85-R-158x60-BK
∞	B85-178x10M-584-YL	Yellow	178.00	10.00	1	B85-R-220x60-BK
∞	B85-250x10M-584-YL	Yellow	250.00	10.00	1	B85-R-220x60-BK



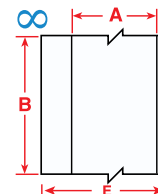
## B-526 BradyGlo high-intensity photoluminescent tape

For glow-in-the-dark identification - up to 10 hours

- Designed for directional and evacuation marking
- Ideal for marking emergency utility shut-offs, fire extinguishers, alarm pulls and vital equipment controls
- Class B material according to the PSPA Performance classification



Diagram	Order Reference	Colour	Width A (mm)	Length B (m)	Labels per Roll	Recommended Ribbon
∞	B85-100x10M-526-GN	Photoluminescent Green	100.00	10.00	1	B85-R-158x60-BK
∞	B85-178x10M-526-GN	Photoluminescent Green	178.00	10.00	1	B85-R-220x60-BK
∞	B85-250x10M-526-GN	Photoluminescent Green	250.00	10.00	1	B85-R-220x60-BK



Clearly indicate safe escape routes leading to emergency exits with our photoluminescent tape.

Contact our Brady distributor for more information about our complete range of marking and signage products.



Choose from a variety of heavy-duty, smear-proof ribbons, including single colour and multi-colour panelled ribbons. These ribbons are uniquely designed with memory cells that communicate information to the BBP85 Sign & Label Printer.

Printer notifies user if the installed ribbon is not recommended for the installed labels.

## Single colour print ribbons

Order Reference	Colour	Width (mm)	Length (m)
B85-R-158x60-BK	Black	158.00	60
B85-R-220x60-BK	Black	220.00	60
B85-R-158x60-BL	Blue	158.00	60
B85-R-220x60-BL	Blue	220.00	60
B85-R-158x60-GN	Green	158.00	60
B85-R-220x60-GN	Green	220.00	60
B85-R-158x60-MA	Magenta	158.00	60
B85-R-220x60-MA	Magenta	220.00	60
B85-R-158x60-OR	Orange	158.00	60
B85-R-220x60-OR	Orange	220.00	60
B85-R-158x60-RD	Red	158.00	60
B85-R-220x60-RD	Red	220.00	60
B85-R-158x60-WT	White	158.00	60
B85-R-220x60-WT	White	220.00	60
B85-R-158x60-YL	Yellow	158.00	60
B85-R-220x60-YL	Yellow	220.00	60



## Two colour panelled print ribbons

Order Reference	Colour	Additional Information	Width (mm)	Length (m)
B85-R-158x60-BK/BL-380P	Black & Blue	Two Colour Ribbon 380mm long Panels	158.00	60
B85-R-220x60-BK/BL-380P	Black & Blue	Two Colour Ribbon 380mm long Panels	220.00	60
B85-R-158x60-BK/GN-200P	Black & Green	Two Colour Ribbon 200mm long Panels	158.00	60
B85-R-158x60-BK/GN-380P	Black & Green	Two Colour Ribbon 380mm long Panels	158.00	60
B85-R-220x60-BK/GN-200P	Black & Green	Two Colour Ribbon 200mm long Panels	220.00	60
B85-R-220x60-BK/GN-380P	Black & Green	Two Colour Ribbon 380mm long Panels	220.00	60
B85-R-158x60-BK/RD-380P	Black & Red	Two Colour Ribbon 380mm long Panels	158.00	60
B85-R-158x60-BK/RD-200P	Black & Red	Two Colour Ribbon 200mm long Panels	158.00	60
B85-R-220x60-BK/RD-380P	Black & Red	Two Colour Ribbon 380mm long Panels	220.00	60
B85-R-220x60-BK/RD-200P	Black & Red	Two Colour Ribbon 200mm long Panels	220.00	60
B85-R-158x60-BK/YL-200P	Black & Yellow	Two Colour Ribbon 200mm long Panels	158.00	60
B85-R-220x60-BK/YL-380P	Black & Yellow	Two Colour Ribbon 380mm long Panels	220.00	60
B85-R-158x60-BK/OR-200P	Black on Orange	Two Colour Ribbon 200mm long Panels	158.00	60
B85-R-220x60-BK/OR-380P	Black on Orange	Two Colour Ribbon 380mm long Panels	220.00	60



## Four colour panelled print ribbons

Order Reference	Colour	Additional Information	Width (mm)	Length (m)
B85-R-158x60-KRBG-380P	Black, Red, Blue, Green	Four Colour Ribbon 380mm long Panels	158.00	60
B85-R-158x60-KRBG-200P	Black, Red, Blue, Green	Four Colour Ribbon 200mm long Panels	158.00	60
B85-R-220x60-KRBG-380P	Black, Red, Blue, Green	Four Colour Ribbon 380mm long Panels	220.00	60
B85-R-220x60-KRBG-200P	Black, Red, Blue, Green	Four Colour Ribbon 200mm long Panels	220.00	60
B85-R-158x60-KRBY-380P	Black, Red, Blue, Yellow	Four Colour Ribbon 380mm long Panels	158.00	60
B85-R-158x60-KRBY-200P	Black, Red, Blue, Yellow	Four Colour Ribbon 200mm long Panels	158.00	60
B85-R-220x60-KRBY-380P	Black, Red, Blue, Yellow	Four Colour Ribbon 380mm long Panels	220.00	60
B85-R-220x60-KRBY-200P	Black, Red, Blue, Yellow	Four Colour Ribbon 200mm long Panels	220.00	60
B85-R-220x60-KROB-200P	Black, Red, Orange, Blue	Four Colour Ribbon 200mm long Panels	220.00	60



# BBP85 at a glance



Watch the how to videos on our Brady YouTube channel.







## BradyJet J2000 and J4000 colour label printers

- 54-57 BradyJet J2000 Colour Label Printer and materials
- 57 BS5609 marine
- 57 Laminates for outdoor durability
- 58-59 BradyJet J4000 Colour Label Printer and materials
- 60 Laminates for outdoor durability
- 60 Full colour tags printable at location
- 60 BS5609 marine
- 61 Create full colour rigid signs with BradyJet
- 61 Print your own Lockout procedures in full colour





The BradyJet J2000 prints on Brady's reliable indoor sign, tag and label materials that stay attached and remain legible when exposed to liquids, alcohol and indoor lighting. They can be counted on to warn coworkers about hazards, or to instruct them on the optimal use or maintenance of machinery.

## Signs that comply and get noticed

With over 16 million colour variations, the new BradyJet J2000 enables customers to print their own, eye-catching safety signs, tags, pipe markers and lean instruction labels to increase workplace safety and efficiency and at the same time comply with any regulatory colour code. Quality images and pictures can be added to any sign thanks to the printer's high, photo-quality printing resolution of 4800 dpi.

## BradyJet J2000 printers

Order Reference	Article No.	Description
J2000-EU	150159	BradyJet J2000 Colour Label Printer - EU
J2000-EU-LABS	199966	BradyJet J2000 Colour Label Printer - EU with Brady Workstation LAB Suite
J2000-EU-SFIDS	199968	BradyJet J2000 Colour Label Printer - EU with Brady Workstation SFID Suite
J2000-UK	150157	BradyJet J2000 Colour Label Printer - UK
J2000-UK-LABS	199967	BradyJet J2000 Colour Label Printer - UK with Brady Workstation LAB Suite
J2000-UK-SFIDS	199969	BradyJet J2000 Colour Label Printer - UK with Brady Workstation SFID Suite
J2000	150162	BradyJet J2000 Colour Label Printer - US
J2000-US-LABS	199971	BradyJet J2000 Colour Label Printer - US with Brady Workstation LAB Suite
J2000-US-SFIDS	199972	BradyJet J2000 Colour Label Printer - US with Brady Workstation SFID Suite



The Basic Suite is included with every printer, download it: [Workstation.BradyID.com/Free](http://Workstation.BradyID.com/Free)



Create custom signs, labels and pipemarkers with [WorkStation.BradyID.com/SFID](http://WorkStation.BradyID.com/SFID)



## BradyJet J2000 accessories

Order Reference	Article No.	Description
J20-CUTTER	150160	Replacement Cutter Blade for J2000
J20-PAD	150163	Replacement Ink Pads for J2000

## BradyJet J2000 inks

Order Reference	Article No.	Description
J20-CMY	150154	CMY pigment based ink cartridge for J2000 Printer



## Easy to use

With 26.4 by 38.9 cm dimensions, the BradyJet J2000 has a small footprint and is very practical and easy to use. Spring loaded Brady label rolls can be switched in less than 20 seconds and with automatic label set up, the printer is ready to print in no time. And with up to 63.5 mm per second print speed, even larger colour coded sample labels can quickly be printed on demand.



Safety signage

CLP/GHS

Pipe marking

Evacuation map

Lean/5S

Facility signage

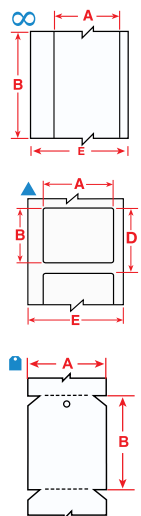
## Printer specifications

Print Resolution (dpi)	Up to 4800 dpi
Print Technology	Inkjet
Colour Capability	Full Colour
Continuous vs Die-cut Labels	Continuous Tape & Die Cut Labels
Max. Label Width (mm)	101.60
Max. Print Width (mm)	101.60
Max. Print Length	609.60
Cutter	Auto Cutter
Print Speed (mm/sec)	63.50
PC Connectivity	Yes
Software Compatibility	Brady Workstation, Windows based driver for 3rd party software use
Connectivity Options	USB
Height x Width x Height (mm)	180 x 264 x 389
Weight (kg)	3.20
Operating Temperature	15°C - 32°C
Approval/Compliance	USA: UL, FCC Class A; Canada: cUL, IC/ISED; European Union : CE, RoHS 2011/65/EU, 2014/35/EU, LVD, 2014/30/EU, RED 2014/53/EU; Australia/New Zealand : RCM
Warranty	1 year



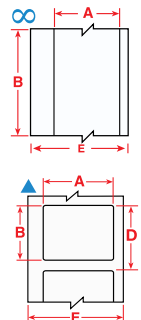
## J2000 SFID materials

Diagram	Order Reference	Art. No.	Colour	Label Width A (mm)	Label Height B (mm)	Label Length B (m)	Total Qty/Pack
<b>Inkjet Receptive Polyester</b>							
∞	J20C-1125-2569	150021	White	29.00	–	30.00	1
∞	J20C-2250-2569	150031	White	57.00	–	30.00	1
∞	J20C-4000-2569	150009	White	101.00	–	30.00	1
▲	J20-260-2569	150026	White	55.00	85.00	–	340
▲	J20-261-2569	150003	White	75.00	110.00	–	270
▲	J20-262-2569	150029	White	105.00	155.00	–	200
<b>Inkjet Receptive Vinyl</b>							
∞	J20C-1125-2595	150010	White	29.00	–	30.00	1
∞	J20C-2250-2595	150014	White	57.00	–	30.00	1
∞	J20C-4000-2595	150017	White	101.00	–	30.00	1
▲	J20-260-2595	150013	White	55.00	85.00	–	340
▲	J20-261-2595	150027	White	75.00	110.00	–	270
▲	J20-262-2595	150032	White	105.00	155.00	–	200
<b>Polyester with inkjet receptive vinyl topcoat</b>							
∞	J20C-2500-2551	150012	White	64.00	–	15.24	1
∞	J20C-3250-2551	150008	White	83.00	–	15.24	1
🔒	J20-255-2551	150030	White	82.55	146.05	–	100



## J2000 CLP materials

Diagram	Order Reference	Art. No.	Colour	Label Width A (mm)	Label Height B (mm)	Label Length B (m)	Total Qty/Pack
<b>Inkjet Receptive Polypropylene</b>							
∞	J20C-1125-7425J	150542	White	29.00	–	30 m	1
∞	J20C-2250-7425J	150547	White	57.00	–	30 m	1
▲	J20-18-7425J	150545	White	76.20	25.40	–	1000
▲	J20-260-7425J	150543	White	55.00	85.00	–	340
▲	J20-261-7425J	150541	White	75.00	110.00	–	270
▲	J20-262-7425J	150544	White	105.00	155.00	–	200
<b>Inkjet Receptive Vinyl</b>							
∞	J20C-1125-2595	150010	White	29.00	–	30 m	1
∞	J20C-2250-2595	150014	White	57.00	–	30 m	1
∞	J20C-4000-2595	150017	White	101.00	–	30 m	1
▲	J20-18-2595	150546	White	76.20	25.40	–	1000
▲	J20-260-2595	150013	White	55.00	85.00	–	340
▲	J20-261-2595	150027	White	75.00	110.00	–	270
▲	J20-262-2595	150032	White	105.00	155.00	–	200



### Brady Workstation safety and facility identification software suite

Keep your facility safe and compliant by creating custom signs, label and pipemarkers, adding visual safety guidance.

[Workstation.BradyID.com/SafetyAndFacility](http://Workstation.BradyID.com/SafetyAndFacility)





## B-2581 repositionable vinyl labels

Position your labels perfectly with Repositionable Labels that are designed to adhere when you need identification, and remove cleanly without leaving residue behind.

- Ideal for inventory marking, Lean/5S projects and identification of reusable containers
- Service temperature of -40 to 140° F (-40 to 60° C)



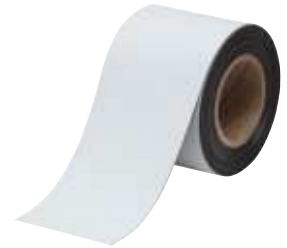
Order Reference	Article No.	Description	Width A (mm)	Length B (m)	Labels per Roll
J20C-1125-2581	151107	Continuous Repositionable Tape for J2000 Printer	28.58	30.48	1
J20C-2250-2581	151108	Continuous Repositionable Tape for J2000 Printer	57.15	30.48	1
J20C-4000-2581	151109	Continuous Repositionable Tape for J2000 Printer	101.60	30.48	1
J50C-2250-2581	151110	BradyJet J4000/J5000 Repositionable Vinyl Labels	57.15	30.48	1
J50C-4000-2581	151111	BradyJet J4000/J5000 Repositionable Vinyl Labels	101.60	30.48	1
J50C-6000-2581	151112	BradyJet J4000/J5000 Repositionable Vinyl Labels	152.40	30.48	1
J50C-8000-2581	151113	BradyJet J4000/J5000 Repositionable Vinyl Labels	203.20	30.48	1



## B-2509 magnetic polyester labels

Reduce and reuse in your rotating inventory areas with Magnetic Labels.

- Get fast and easy identification changes on your metallic surfaces
- Ideal for shelves, drawers, bins, Lean/5S and warehouse and inventory racking



Order Reference	Article No.	Description	Width A (mm)	Length B (m)	Labels per Roll
J20C-2500-2509	151114	Continuous Magnetic Tape for J2000 Printer	63.50	7.62	1
J50C-2500-2509	151116	Continuous Magnetic Tape for J5000 Printer	63.50	7.62	1
J50C-4250-2509	151117	Continuous Magnetic Tape for J5000 Printer	107.95	7.62	1
J50C-6000-2509	151118	Continuous Magnetic Tape for J5000 Printer	152.40	7.62	1



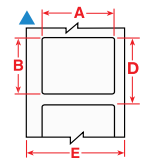
## B-2550 paper labels

Paper Labels offer an economical solution to your labelling needs.

- Ideal for light duty, temporary and general identification labelling
- Provides excellent contrast and smear resistance for barcode printing



Diagram	Order Reference	Article No.	Description	Width A (mm)	Length B (m)	Labels per Roll
▲	J20-164-2550	151119	Paper Labels for J2000 Printer	22.86	-	1200
▲	J20-235-2550	151120	Paper Labels for J2000 Printer	40.39	-	1050
▲	J20-88-2550	151121	Paper Labels for J2000 Printer	25.40	-	2700
▲	J20-256-2550	151122	Paper Labels for J2000 Printer	33.02	-	1600
▲	J20-17-2550	151123	Paper Labels for J2000 Printer	50.80	-	1000
▲	J20-53-2550	151124	Paper Labels for J2000 Printer	50.80	-	1900
▲	J20-166-2550	151125	Paper Labels for J2000 Printer	63.50	-	850
▲	J20-7-2550	151126	Paper Labels for J2000 Printer	69.85	-	850
▲	J20-18-2550	151127	Paper Labels for J2000 Printer	76.20	-	1050
▲	J20-19-2550	151128	Paper Labels for J2000 Printer	76.20	-	550
▲	J20-20-2550	151129	Paper Labels for J2000 Printer	76.20	-	200
▲	J20-77-2550	151130	Paper Labels for J2000 Printer	101.60	-	280
▲	J20-25-2550	151131	Paper Labels for J2000 Printer	101.60	-	180
▲	J20-55-2550	151132	Paper Labels for J2000 Printer	101.60	-	550
▲	J20C-2000-2550	151133	Continuous Paper Tape for J2000 Printer	50.80	30.48	1
▲	J20C-3000-2550	151134	Continuous Paper Tape for J2000 Printer	76.20	30.48	1
▲	J20C-4000-2550	151135	Continuous Paper Tape for J2000 Printer	101.60	30.48	1



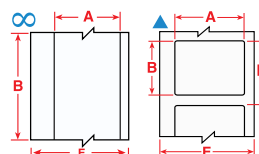


## B-403 dissolvable paper labels

The water dissolvable paper label is self-adhesive and extremely easy to apply. Exposing the label to warm water will completely dissolve it within 30 seconds, without damage to the surface it was applied to, and without leaving any residue. It reduces the labour required to remove labels, reduces maintenance to filters and drains and enables easy re-identification of reusable items in a range of industries.



Diagram	Order Reference	Art. No.	Description	Width A (mm)	Length B (m)	Labels per Roll
	J20C-1125-403	151239	Continuous Dissolvable Paper Tape for J2000 Printer	28.6	30.48	1
	J20C-2250-403	151240	Continuous Dissolvable Paper Tape for J2000 Printer	57.15	30.48	1
	J20-55-403	151241	Dissolvable Paper Labels for J2000 Printer	101.60	-	250
	J20-17-403	151243	Dissolvable Paper Labels for J2000 Printer	50.80	-	1500
	J20-19-403	151244	Dissolvable Paper Labels for J2000 Printer	76.20	-	350



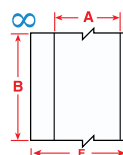
## BS5609 marine

The BS5609 certified label materials B-595, B-2585 and B-7569 can be printed at your location using a quality sign & label printer from Brady, such as the BBP35, BBP37, BradyJet J2000, J4000 or BradyJet J5000. Labels with black & red print on white backgrounds, like CLP-labels, can easily be created with these printers and Brady's CLP-app in port, at sea or off-shore to address ad hoc identification needs. Other applications, such as full colour safety signs and pipe markers, can also be printed on-site or at the Brady factory.

- Stays attached and legible for 3 months in the sea
- Can be printed in full colour with the BradyJet J2000, J4000 or BradyJet J5000
- Enter name or CAS number in our app to auto-design compliant GHS/CLP labels



Diagram	Order Reference	Art. No.	Description	Width A (mm)	Length B (m)	Labels per Roll
	J20C-2250-2585	150758	Continuous Polypropylene Tape for J2000 Printer	57.15	30.48	1
	J20C-4000-2585	150759	Continuous Polypropylene Tape for J2000 Printer	101.60	30.48	1
	J50C-2250-2585	150760	BradyJet J4000 J5000 BS 5609 Marine Labels	57.00	30.00	1
	J50C-4000-2585	150761	BradyJet J4000 J5000 BS 5609 Marine Labels	101.00	30.00	1
	J50C-6000-2585	150762	BradyJet J4000 J5000 BS 5609 Marine Labels	152.00	30.00	1
	J50C-8000-2585	150763	BradyJet J4000 J5000 BS 5609 Marine Labels	203.20	30.00	1



## Laminates for outdoor durability

The BradyJet Colour Label Printers are able to quickly print full colour signs and labels with indoor durability. By applying a laminate, these on-site printed full colour signs and labels can be given 3 year outdoor durability, considerably expanding the printer's applications. 4 sizes of laminates can be applied, and each laminate is 12 mm wider than its corresponding label material for easier application of the laminate.



Order Reference	Article No.	Description	Width A (mm)	Length B (m)	Labels per Roll
LAM-6000-910	149257	Overlaminates for J4000 and J5000 Printer Consumables	165.10	-	1
LAM-4000-910	149258	Overlaminates for J2000, J4000 and J5000 Printer Consumables	114.30	-	1
LAM-2250-910	149259	Overlaminates for J2000, J4000 and J5000 Printer Consumables	69.85	-	1
LAM-8000-910	149260	Overlaminates for J4000 and J5000 Printer Consumables	215.90	-	1



### Design any label with Brady Workstation apps

Brady Workstation offers professional, intuitive apps to design quality product and cable labels and safety signs. Label design becomes easier, faster and quickly adaptable to new label norms thanks to centralised updates.

Simply download Brady Workstation to your desktop and add the applications you need:

[www.workstation.bradyid.com](http://www.workstation.bradyid.com)





## BradyJet J4000

COLOUR LABEL PRINTER

The BradyJet J4000 Colour Label Printer is an industrial high quality printer. The wide format full colour inkjet label printer is very easy to use and prints reliable, high resolution signs, facility and laboratory sample labels in bright, vibrant colours to support workplace safety and efficiency. The printer includes the Brady Workstation Basic Software Suite for label design.

### More time for critical tasks

When the printer does the busy work, you have more time to focus on the important work needed to keep your operations running smoothly.

### BradyJet J4000 printer

Order Reference	Article No.	Description
J4000-EU	152711	BradyJet J4000 Colour Label Printer
J4000-EU-BWSSFD	310388	BradyJet J4000 Colour Label Printer with Safety and Facility ID Software
J4000-EU-BWSLABS	310390	BradyJet J4000 Colour Label Printer with Laboratory Software
J4000-EU-BWSPWID	310389	BradyJet J4000 Colour Label Printer with Product and Wire ID Software
J4000-UK	152712	BradyJet J4000 Colour Label Printer
J4000-UK-BWSSFD	310391	BradyJet J4000 Colour Label Printer with Safety and Facility ID Software
J4000-UK-BWSLABS	310393	BradyJet J4000 Colour Label Printer with Laboratory Software
J4000-UK-BWSPWID	310392	BradyJet J4000 Colour Label Printer with Product and Wire ID Software
J4000-US	152710	BradyJet J4000 Colour Label Printer
J4000-US-BWSSFD	310442	BradyJet J4000 Colour Label Printer with Safety and Facility ID Software
J4000-US-BWSLABS	310444	BradyJet J4000 Colour Label Printer with Laboratory Software
J4000-US-BWSPWID	310443	BradyJet J4000 Colour Label Printer with Product and Wire ID Software



### Prints well with others

Create however it works best for you, then easily print PDFs or from third-party software packages with the optimised Windows driver.



Keep your facility safe and compliant by creating custom signs, label and pipemarkers, adding visual safety guidance. [Workstation.BradyID.com/SafetyAndFacility](http://Workstation.BradyID.com/SafetyAndFacility)



Quickly identify your products and wires with customised text or graphical labels, using serialised or imported data. Quickly identify your products and wires with customised text or graphical labels, using serialised or imported data. [Workstation.BradyID.com/ProductandWire](http://Workstation.BradyID.com/ProductandWire)



Ensure labels for all your lab samples and equipment are crisp, clear, readable and contain all necessary information. Easily design and create labels for your cryovials, centrifuge tubes, bottles, conicals, slides and other samples in your laboratory. [Workstation.BradyID.com/LAB](http://Workstation.BradyID.com/LAB)



### BradyJet J4000 ink and storage caps

Order Reference	Article No.	Description
152713	J40-CAP	J4000 Ink Cartridge Storage Caps
152714	J40-CMY	BradyJet J4000 Full Colour Ink Cartridge



Safety signage



CLP/GHS



Pipe marking



Evacuation map



Lean/5S



Facility signage

# Quickly print full colour durable signs & labels

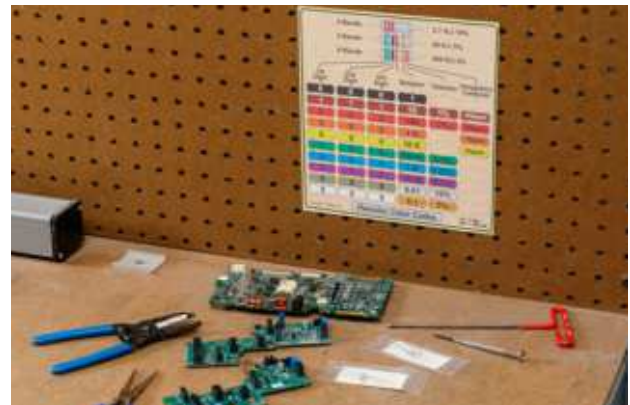
The BradyJet J4000 Colour Label Printer quickly prints full colour safety and lean signs, logos and images in photo-quality on durable materials.

## Printer Specifications

Print Resolution (dpi)	Up to 4800
Print Technology	Inkjet
Colour Capability	Full Colour
Continuous vs Die-cut Labels	Continuous Tape & Die Cut Labels
Max. Label Width (mm)	209.55
Max. Print Width (mm)	203.2
Max. Print Length (mm)	609.6
Cutter	After label, at end of job or no cutoff. Auto Cutter
Print Speed (mm/sec)	114.30
PC Connectivity	Yes
Software Compatibility	Brady Workstation, Windows based driver for 3rd party software use
Connectivity Options	USB, Ethernet
Height x Width x Depth (mm)	231.14 x 438.15 x 438.15
Weight (kg)	16
Display	LED
Operating Temperature	15°C-32°C
Approval/Compliance	UL, FCC ClassA, cUL, CE, 2011/65/EU, 2015/863/EU RoHS2
Warranty	1 year

## Fast

Print full colour signs and labels in one pass at a top speed of 114 mm per second. That makes the BradyJet J4000 Colour Label Printer a great peripheral tool for any company that needs to quickly add or renew indoor safety signs, lean labels or pipe markers.

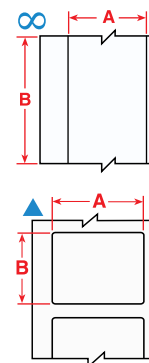


## Durable

The BradyJet J4000 Colour Label Printer prints on Brady's durable B-2595 vinyl and B-2569 polyester sign and label material range. These labels feature a topcoat that enhances the colour and label appearance, and protects your print from smudging and harsh conditions. The labels have been tested to withstand exposure to liquids, alcohol and chemicals. Available in sizes ranging from 55.00 to 203.20 mm for the BradyJet J4000 Colour Label Printer.

## B-2595/B-2569 Inkjet receptive polyester and vinyl labels for BradyJet J4000 and J5000

Diagram	Order Reference	Colour	Width A (mm)	Height B (mm)	Length B (m)	Labels per Roll
<b>Inkjet Receptive Polyester</b>						
∞	J50C-2250-2569	White	57.00	-	30	1
∞	J50C-4000-2569	White	101.00	-	30	1
∞	J50C-6000-2569	White	152.00	-	30	1
∞	J50C-8000-2569	White	203.20	-	30	1
▲	J50-260-2569	White	55.00	85.00	-	340
▲	J50-261-2569	White	75.00	110.00	-	270
▲	J50-262-2569	White	105.00	155.00	-	200
▲	J50-267-2569	White	155.00	210.00	-	120
▲	J50-265-2569	White	178.00	254.00	-	100
<b>Inkjet Receptive Vinyl</b>						
∞	J50C-2250-2595	White	57.00	-	30	1
∞	J50C-4000-2595	White	101.00	-	30	1
∞	J50C-6000-2595	White	152.00	-	30	1
∞	J50C-8000-2595	White	203.20	-	30	1
▲	J50-260-2595	White	55.00	85.00	-	340
▲	J50-261-2595	White	75.00	110.00	-	270
▲	J50-262-2595	White	105.00	155.00	-	200
▲	J50-267-2595	White	155.00	210.00	-	120
▲	J50-265-2595	White	178.00	254.00	-	100





## Laminates for outdoor durability

The BradyJet J4000 Colour Label Printer is able to quickly print full colour signs and labels with indoor durability. By applying a laminate, these on-site printed full colour signs and labels can be given 3 year outdoor durability, considerably expanding the printer's applications. 4 sizes of laminates can be applied, and each laminate is 12 mm wider than its corresponding label material for easier application of the laminate.



Order Reference	Article No.	Description	Width A (mm)	Length B (m)	Labels per Roll
LAM-6000-910	149257	Overlamine for J4000 and J5000 Printer Consumables	165.10	-	1
LAM-4000-910	149258	Overlamine for J2000, J4000 and J5000 Printer Consumables	114.30	-	1
LAM-2250-910	149259	Overlamine for J2000, J4000 and J5000 Printer Consumables	69.85	-	1
LAM-8000-910	149260	Overlamine for J4000 and J5000 Printer Consumables	215.90	-	1

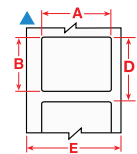


## BS5609 marine

The BS5609 certified label materials B-595, B-2585 and B-7569 can be printed at your location using a quality sign & label printer from Brady, such as the BBP35, BBP37, BradyJet J2000, J4000 or BradyJet J5000. Labels with black & red print on white backgrounds, like CLP-labels, can easily be created with these printers and Brady's CLP-app in port, at sea or off-shore to address ad hoc identification needs. Other applications, such as full colour safety signs and pipe markers, can also be printed on-site or at the Brady factory.

- Stays attached and legible for 3 months in the sea
- Can be printed in full colour with the BradyJet J2000; J4000 or BradyJet J5000
- Enter name or CAS number in our app to auto-design compliant GHS/CLP labels

Diagram	Order Reference	Art. No.	Colour	Label Width A (mm)	Label Height B (mm)	Label Length B (m)	Labels per Roll
∞	J50C-2250-2585	150760	White	57.15	-	30.48 m	1
∞	J50C-4000-2585	150761	White	101.60	-	30.48 m	1
∞	J50C-6000-2585	150762	White	152.40	-	30.48 m	1
∞	J50C-8000-2585	150763	White	203.20	-	30.48 m	1
▲	J50-260-2585	150753	White	55.00	85.00	-	340
▲	J50-261-2585	150754	White	75.00	110.00	-	270
▲	J50-262-2585	150755	White	105.00	155.00	-	200
▲	J50-267-2585	150756	White	154.90	210.00	-	120
▲	J50-268-2585	150757	White	203.00	279.40	-	100



## B-2551 Polyester Tags

B-2551 material is a thick, polyester tagstock with an inkjet-receptive vinyl adhered.

- Ideal for use in general facility labelling, including accident prevention, confined space tags and Lockout/Tagout tags
- Ideal for on-the-spot dangerous condition warnings
- Tags are pre-perforated and feature chamfered corners
- Tags on a roll separate cleanly

Order Reference	Article No.	Description	Width A (mm)	Height B (mm)	Labels per Roll
J40-385-2551	170396	Polyester Tags for J4000 Printers	82.55	146.05	100



## B-2581 Repositionable vinyl material

The material can be printed in full colour at your premises when you need them and they are designed for frequent repositioning.

Diagram	Order Reference	Art. No.	Colour	Label Width A (mm)	Label Height B (mm)	Label Length B (m)	Labels per Roll
∞	J50C-2250-2581	151110	White	57.15	-	30.48 m	1
∞	J50C-4000-2581	151111	White	101.60	-	30.48 m	1
∞	J50C-6000-2581	151112	White	152.40	-	30.48 m	1
∞	J50C-8000-2581	151113	White	203.20	-	30.48 m	1



## B-2475 Polyester material

Ideal for product labelling, logos, Right to Know labels and barcode applications. UL approved.



Diagram	Order Reference	Art. No.	Colour	Label Width A (mm)	Label Height B (mm)	Label Length B (m)	Labels per Roll
∞	J40C-1125-2475	152809	White	28,58	–	30,48 m	1
∞	J40C-2250-2475	152810	White	57,15	–	30,48 m	1
∞	J40C-4000-2475	152811	White	101,60	–	30,48 m	1
∞	J40C-8000-2475	152812	White	203,20	–	30,48 m	1
▲	J40-136-2475	152802	White	38,10	19,05	–	1000
▲	J40-235-2475	152803	White	38,10	25,40	–	750
▲	J40-137-2475	152804	White	50,80	25,40	–	750
▲	J40-18-2475	152805	White	76,20	25,40	–	750
▲	J40-19-2475	152806	White	76,20	50,80	–	250
▲	J40-55-2475	152807	White	101,60	50,80	–	250
▲	J40-25-2475	152808	White	101,60	152,40	–	80

## B-7425J Chemically resistant polypropylene material

This polypropylene material is ideal for GHS and other full-colour identification applications where resistance to harsh chemicals is required.



Diagram	Order Reference	Art. No.	Colour	Label Width A (mm)	Label Height B (mm)	Label Length B (m)	Labels per Roll
∞	J40C-2250-7425J	152783	White	57,15	–	30,48 m	1
∞	J40C-4000-7425J	152784	White	101,60	–	30,48 m	1
∞	J40C-6000-7425J	152785	White	152,40	–	30,48 m	1
∞	J40C-8000-7425J	152786	White	203,20	–	30,48 m	1
▲	J40-260-7425J	152778	White	55,00	85,00	–	340
▲	J40-321-2475J	152781	White	203,20	133,35	–	100
▲	J40-262-7425J	152779	White	104,90	155,00	–	200
▲	J40-265-7425J	152780	White	177,80	254,00	–	100
▲	J40-268-2475J	152782	White	203,20	279,40	–	100

# Design, print and manage your labelling with software

## Brady Workstation Desktop-Software

Design and print labels seamlessly with Brady Workstation software suites and apps specially designed for a variety of common industry-related tasks. Along with popular time-saving features like auto-formatting and built-in templates, Brady Workstation features an intuitive interface that integrates seamlessly with the work you do.

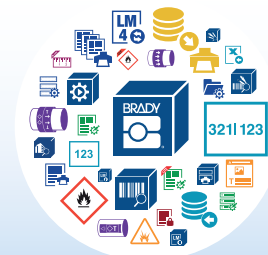


### Design any label with Brady Workstation apps

Brady Workstation offers professional, intuitive apps to design quality product and cable labels and safety signs. Label design becomes easier, faster and quickly adaptable to new label norms thanks to centralised updates.

Simply download Brady Workstation to your desktop and add the applications you need:

[www.workstation.bradyid.com](http://www.workstation.bradyid.com)





This section provides a quick reference to Brady materials listed throughout this catalogue, including basic attributes, applications and regulatory compliance where applicable. For more detailed material attribute and performance information, please refer to the material's Technical Data Sheet, listed at [www.bradyeurope.com/tds](http://www.bradyeurope.com/tds).

Brady Material No.	Material	Print Technology	Finish	Colour	Temp (°C) (Tested for 30 days)		Properties & Applications	Approval/Compliance
					Min.	Max.		
B-2509	Magnetic Polyester	Inkjet	Matt	White	-40 °C	60 °C	B-2509 is an aqueous inkjet printable label, with matt finish that adheres via magnetic attraction. These are ideal for temporary, reusable and movable signs	–
B-2550	Inkjet Receptive Paper	Inkjet	Matt	White	-40 °C	60 °C	B-2550 white paper label stock is an aqueous inkjet printable, matt finish, pressure sensitive adhesive product. B-2550 is designed to be used with the BradyJet™ J2000 Colour Label Printer. Aqueous inkjet printable paper label stock that yields full colour and high resolution graphics.	–
B-2551	Heavy Duty Polyester	Inkjet	Matt	White	-40 °C	60 °C	B-2551 indoor marking tag stock is an aqueous inkjet receptive, rigid, matt finish, tag product, designed for use in roll form with the BradyJet J2000 and J5000 Colour Label Printers. B-2551 enables compliance if printed and applied according to standards for tag out tags and lockout tags.	Complies to OSHA 1910.145(f) when printed with required signal word and major message.
B-2569	Inkjet Receptive Polyester	Inkjet	Matt	White	-40 °C	60 °C	B2569 is a polyester indoor marking material used indoors for Pipemarkers, Arrow Tape, Warehouse Marking, Warning Panels, Safety Signs, Arc Flash and Visual Workplace labels.	–
B-2581	Inkjet Receptive Vinyl	Inkjet	Matt	White	-40 °C	60 °C	B-2581 is an aqueous inkjet printable vinyl with matt finish and repositionable adhesive. Ideal for labelling where frequent repositioning may be required	–
B-2585	Polypropylene	Inkjet	Matt	White	-40 °C	60 °C	B-2585 is an aqueous inkjet printable polypropylene, with a matt finish and permanent acrylic adhesive. Suitable for international container labelling where coloured identification is required	BS5609:1986 Section 2 and section 3
B-2595	Inkjet Receptive Vinyl	Inkjet	Matt	White	-40 °C	60 °C	B-2595 is a vinyl indoor marking material used indoors for Pipemarkers, Arrow Tape, Warehouse Marking, Warning Panels, Safety Signs, Arc Flash and Visual Workplace labels.	–
B-403	Paper	Thermal Transfer	Matt	Black on White	-70 °C	100 °C	White dissolvable paper. Dissolves completely in water leaving no adhesive residue, ideal for temporary labelling applications	–
B-483A/B-634	Polyester with Polyester Overlaminates	Thermal Transfer	Gloss	White	-18 °C	54 °C	ToughStripe™ floor marking thermal transfer printable polyester with ultra-aggressive adhesive which allows for printable messages to be placed on the floor. The floor marking roll ships with a separate roll of B-634 Polyester Overlaminates to protect your legend. Ideal to create custom-printed floor labels. Available in white, yellow, red, orange, green, blue and black.	–
B-509	Magnetic Polyester	Thermal Transfer	Matt	White	-18 °C	70 °C	Magnetic Back Polyester is used for temporary, reusable and movable signs	–
B-526	Phosphorescent Polyester	Thermal Transfer	Gloss	Photoluminescent Green	-40 °C	60 °C	BradyGlo™ High Intensity laminate is designed to provide high adhesion and luminance for egress marking in low light areas in and along stairwells of public buildings, exit and directional signs, identification of fire alarms and extinguishers, low location egress pathway markings, and directional systems for escape or evacuation routes.	New York Local Law 26 RS 6-1 & 6-1A; City of New York, Department of Buildings MEA No. 467-06-M UV: 46-9-7
B-530	Tamper-resistant Vinyl	Thermal Transfer	Gloss	White	-40 °C	90 °C	Brady's tamper resistant tape destructs into tiny fragments when tampered with.	–
B-549	Polyester	Thermal Transfer	Gloss	White	-40 °C	100 °C	Flexible, dimensionally stable, low temperature, pressure sensitive adhesive tape for permanent application. Adhesive can be applied at temperatures down to -10°F (-23°C).	–
B-551	Polyester Tag	Thermal Transfer	Matt	White	-40 °C	89 °C	Tag material used for marking on-the-spot warning of dangerous conditions	Complies to OSHA 1910.145(f) when printed with required signal word and major message.

Brady Material No.	Material	Print Technology	Finish	Colour	Temp (°C) (Tested for 30 days)		Properties & Applications	Approval/Compliance
					Min.	Max.		
B-526	Phosphorescent Polyester	Thermal Transfer	Gloss	Photoluminescent Green	-40 °C	60 °C	BradyGlo™ High Intensity laminate is designed to provide high adhesion and luminance for egress marking in low light areas in and along stairwells of public buildings, exit and directional signs, identification of fire alarms and extinguishers, low location egress pathway markings, and directional systems for escape or evacuation routes.	New York Local Law 26 RS 6-1 & 6-1A; City of New York, Department of Buildings MEA No. 467-06-M UV: 46-9-7
B-530	Tamper-resistant Vinyl	Thermal Transfer	Gloss	White	-40 °C	90 °C	Brady's tamper resistant tape destructs into tiny fragments when tampered with.	—
B-549	Polyester	Thermal Transfer	Gloss	White	-40 °C	100 °C	Flexible, dimensionally stable, low temperature, pressure sensitive adhesive tape for permanent application. Adhesive can be applied at temperatures down to -10°F (-23°C).	—
B-551	Polyester Tag	Thermal Transfer	Matt	White	-40 °C	89 °C	Tag material used for marking on-the-spot warning of dangerous conditions	Complies to OSHA 1910.145(f) when printed with required signal word and major message.
B-569	Polyester	Thermal Transfer	Gloss	Green	-40 °C	100 °C	Designed for use on stainless steel pipes in harsh environments such as the Pulp and Paper Industry	—
B-581	Vinyl	Thermal Transfer	Gloss	White	-40 °C	82 °C	Only indoor use, where frequent repositioning is required	—
B-582	Phosphorescent Polyester	Thermal Transfer	Gloss	Photoluminescent Green	-40 °C	80 °C	Phosphorescent Polyester is used for exit and directional signs, identification of fire alarms and extinguishers, low location egress pathway markings, and directional systems for escape or evacuations routes.	ASTM E-2072-00 / ASTM E-2073-00; ASTM E-162; ASTM E-648; ASTM E-662; IMO Resolution A.752(18); ISO/CD 15370; Marine Safety Committee MSC.27(61); DIN 67510 (Parts 1 - 4) Meets OSHA 1910.37
B-584	Reflective Tape	Thermal Transfer	Gloss	Orange	-40 °C	70 °C	Suitable for outdoor use. Also available in silver and yellow.	—
B-593	Polyester	Thermal Transfer	Gloss	White	-20 °C	100 °C	EPREP (Engraved Panel REplacement labels) are designed for patch panel identification in identifying external push-buttons, switches and internal connection points. Also available in black, green, red, silver and yellow.	UL Recognised; cUL Recognised
B-595	Vinyl	Thermal Transfer	Gloss	White	-40 °C	82 °C	Durable, low-shrink vinyl with our most aggressive adhesive. Conforms to irregular, curved, rough and highly textured surfaces (painted cinder blocks, uneven wood, textured plastics, paper-jacketed pipes, powder-coated surfaces). Adheres to "difficult" low-surface energy items (PVC piping, blow-moulded equipment cases, ABS plastics, recycled plastics). Available in a wide range of colours.	BS5609:1986 Section 2 and section 3
B-7425J	Inkjet Receptive Polypropylene	Inkjet	Matt	White	-80 °C	70 °C	B-7425J is a inkjet receptive material with a matt finish and permanent acrylic adhesive. Suitable for printing coloured laboratory labels such as vials, centrifuge and test tubes	—
B-7569	Vinyl	Thermal Transfer	Gloss	White	-20 °C	75 °C	Used for Pipe Markers, Arrow Tape, Warehouse Marking, Floor Marking, Warning Panels, Safety Signs and Hazardous Substance Identification. Available in a wide range of colours.	BS5609:1986 Section 2 and section 3
B-7593	Polyethylene Foam Laminate Polyester	Thermal Transfer	Gloss	White, Yellow, Red, Green, Silver, Black	-40 °C	100 °C	EPREP (Engraved Panel REplacement labels) are designed for patch panel identification in identifying external push-buttons, switches and internal connection points. Also available in black, green, red, silver and yellow.	—
B-851	Polyester	Thermal Transfer		Red on White	-40 °C	100 °C		Complies to OSHA 1910.145(f) when printed with required signal word and major message.
B-854	Metal Detectable Polyester	Thermal Transfer	Matt	White	-40 °C	110 °C	Tough against harsh washdown environments; metal detectable. Also available in yellow.	—
B-855	Polyester	Thermal Transfer	Matt	White	-40 °C	110 °C	Tough against harsh washdown environments. Also available in yellow.	—
B-910	Acrylic		Gloss	Transparent	-29 °C	150 °C	Overlaminates for J4000 and J5000 Printer Consumables	—



#### Africa

Randburg, South Africa  
Tel.: +27 11 704 3295  
Email: [africa@bradycorp.com](mailto:africa@bradycorp.com)

#### Benelux

Zeleville, Belgium  
Tel.: +32 (0) 52 45 78 11  
Email: [benelux@bradycorp.com](mailto:benelux@bradycorp.com)

#### Central & Eastern Europe

Bratislava, Slovakia  
Tel.: +421 2 3300 4800  
Email: [central\\_europe@bradycorp.com](mailto:central_europe@bradycorp.com)

#### Denmark

Odense  
Tel.: +45 66 14 44 00  
Email: [denmark@bradycorp.com](mailto:denmark@bradycorp.com)

#### France

Roncq  
Tel.: +33 (0) 3 20 76 94 48  
Email: [france@bradycorp.com](mailto:france@bradycorp.com)

#### Germany, Austria & Switzerland

Egelsbach, Germany  
Tel.: +49 (0) 6103 7598 660  
Email: [germany@bradycorp.com](mailto:germany@bradycorp.com)

#### Hungary

Budaörs  
Tel.: +36 23 500 275  
Email: [hungary@bradycorp.com](mailto:hungary@bradycorp.com)

#### Italy

Gorgonzola  
Tel.: +39 02 26 00 00 22  
Email: [italy@bradycorp.com](mailto:italy@bradycorp.com)

#### Middle East FZE

Dubai, UAE  
Tel.: +971 4881 2524  
Email: [cs\\_me@bradycorp.com](mailto:cs_me@bradycorp.com)

#### Norway

Kjeller  
Tel.: +47 70 13 40 00  
Email: [norway@bradycorp.com](mailto:norway@bradycorp.com)

#### Spain & Portugal

Madrid, Spain  
Tel.: +34 900 902 993  
Email: [spain@bradycorp.com](mailto:spain@bradycorp.com),  
[portugal@bradycorp.com](mailto:portugal@bradycorp.com)

#### Sweden, Finland, Baltic states

Kista, Sweden  
Tel.: +46 (0) 8 590 057 30  
Email: [sweden@bradyeurope.com](mailto:sweden@bradyeurope.com)

#### Turkey

Istanbul  
Tel.: +90 212 264 02 20 / 264 02 21  
Email: [turkey@bradycorp.com](mailto:turkey@bradycorp.com)

#### UK & Ireland

Banbury, UK  
Tel.: +44 (0) 1295 228 288  
Email: [uk@bradycorp.com](mailto:uk@bradycorp.com)

Our mission is to identify and protect people,  
products and premises



To help minimise our impact on the environment,  
Brady limits its number of reprints.

Updated versions are always available for  
download on [www.bradyeurope.com](http://www.bradyeurope.com).



Search for: EUR-M-801-EN



Y490929

Twój dystrybutor marki Brady:



**HTS-Polska Strzyga sp.j.**  
Wola Piecryska 27  
05-650 Chynów49  
NIP: 797 202 62

T: +48 22 619 07 70  
M: +48 505 612 159  
M: +48 501 753 716  
e-mail: [info@hts-polska.pl](mailto:info@hts-polska.pl)