



**One smart printer to
print it all**

BMP71 Label Printer

About BRADY



Once you have worked with BRADY, our name will stick with you, (just like our labels) because BRADY is one of the world's leading labelling and identification specialists.

Innovative

At BRADY we continue to improve. We have many customers from all industries, and we strive to be ahead of their needs by continuing to invest in research for even more performant solutions. By developing more user-friendly and efficient concepts, we give our thousands of customers the best in the market.

Strength

At BRADY, we believe our biggest strength is the wide range of identification and safety solutions we can offer our customers, whether it's labelling the smallest component or complete signage for an entire warehouse. We're also proud to offer many products and services - from printers, scanners and software to service contracts and on-site training - that compliment any identification job. And don't forget, our wide network of expert distributors can always offer you a tailor-made solution to meet your specific requirements.

Trust

For over a hundred years, BRADY has been connected with quality, trust and stability. We demand the best for your products and services, because we know, better than anyone, the importance of good and reliable identification. Identification looks like a small detail, but every professional knows that this kind of detail is crucial to any business.

Inform

We also have specialised dealers in your region, who can answer all your identification, safety and labelling questions, specific to your activity. They will be happy to provide you with all kinds of options and solutions with no obligation.

Microsoft is a trademark of Microsoft Corporation, Bluetooth is a trademark of Bluetooth Sig, Inc., Android is a trademark of Google Inc.



Brady products are sold on the condition that the purchaser will test them in actual use and determine for himself/herself their suitability to his/her intended purpose. Brady warrants to the purchaser that Brady products are free from defects in material and workmanship but limits its obligation under this warranty to the replacement of the product which has been shown to Brady's satisfaction to have been defective at the time of its purchase.

The warranty does not extend to any persons who have acquired the product from the purchaser. It is in lieu of any other warranty, including every warranty of sale-ability, marketability or suitability for the intended purpose, and is also in lieu of any other obligation or liability on the part of Brady.

Under no circumstances will Brady be liable for losses, damage, costs or subsequent damage of whatever nature which may arise in connection with the use of, or inability to use, Brady's products.

BMP71 Label Printer

The Brady Advantage

When it comes to identification, safety and compliance, there's a clear advantage to working with Brady. We put our customers first in everything we do.

Our goal is to give you an unrivalled customer experience. We are relentlessly committed to performance and excellence - in our products, services and people.

Our products and solutions perform in ways that others simply can't match.

Our people perform in ways that regularly exceed your expectations. And our focus and discipline work toward solid, long-term performance for our customers.

In short, Brady is the company you trust when performance matters most.

Learn more about the Brady Advantage at:
www.bradyeurope.com

Contents

4	One smart printer to print it all
5	BMP71 at a glance
6	Font sizes & symbol library
7	Applications
10	Advantages of labelling
11	What is a professional label?
12	BMP71 media offering
13	Ribbons
14	Electrical, voice/datacom identification
30	General & industrial identification
34	Safety & facility identification
38	Electronics identification
40	Laboratory identification
49	Master material index
52	Brady Workstation software suites
53	Printer specifications
54	BMP71 Printer, kits and accessories
55	Brady Technical Service





One smart printer to print it all

The BMP71 Label Printer is the premium mobile printer. Able to print the widest range of materials, including custom labels, BMP71 features a large and sharp screen, is easily portable and has a built-in keyboard, available in various configurations. Whether you need heat-shrink sleeves, die-cut labels or indoor/outdoor vinyl, you can be confident that the BMP71 printer has the right label material for your application.



Helps you deal with every situation

- Over 500 built-in symbols
- Over 400 parts + customs
- Over 30 different types of label material
- Label width up to 50 mm

Keeps you going on and on

- Rechargeable NiMH battery
- Ideal for 1000 continuous or die-cut labels a day
- 2 year warranty

Shows the whole label at once

- Enlarged full colour screen

Speeds up your labelling

- Swift typing with both hands
- Full Qwerty/Azerty/Qwertz/Cyrillic keyboards
- Fast printing : 38 mm/sec

The BMP71 Label Printer is your essential tool that handles all your label printing needs.

BMP71 at a glance



**2 YEAR
WARRANTY**



Watch the how to videos on our Brady YouTube channel.



Font sizes & symbol library

Variable font sizes

Font sizes range from 4 to 170 point.
The maximum font size available depends on factors such as label size, number of characters, number of lines, as well as font sizes in other lines.

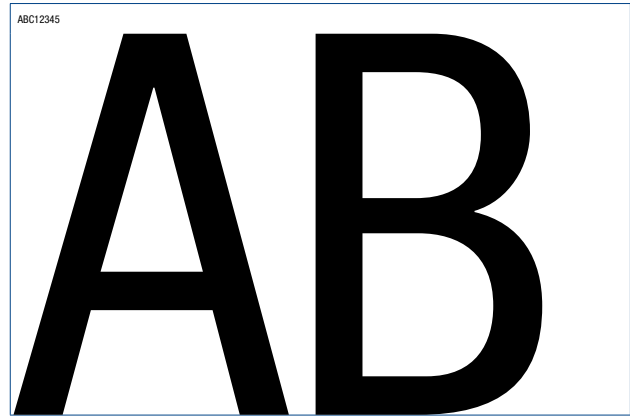

Also available: full height, auto and custom font sizes.

Barcode types



- Code 39 and Code 128
- Other barcodes supported

Symbol library

- Standard electrical and datacom symbols
- Over 500 built-in graphics
- Built-in time/date stamp
- Signs can easily be imported

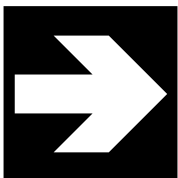

Arrows

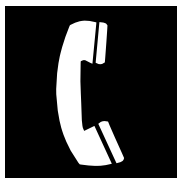

Datacom



Electrical



Exit



Fire



First aid



GHS



International



Mandatory



Misc.



Packaging



PPE



Prohibition



Public info



Safety

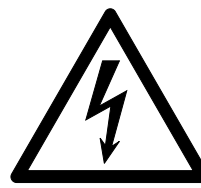

Warning



WHMIS

...and many more

Applications

Electrical, voice/datacom identification

Wire & cable marking for twisted pair data cables (UTP, FTP...), fibre optic cables, conductors, computer wires, electrical installation wires & cables, power & ground cables, energy cables...



Sleeves



Self-lams



Wrap-around labels

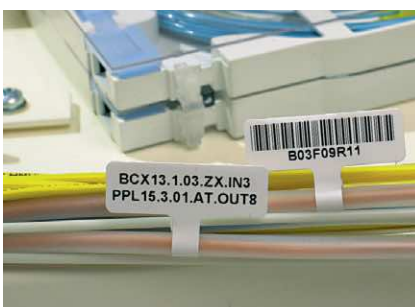

Flags



Tags

Component marking for patch panels, control panels, punch blocks, terminal blocks, breaker boxes, face-plates...



Raised panels

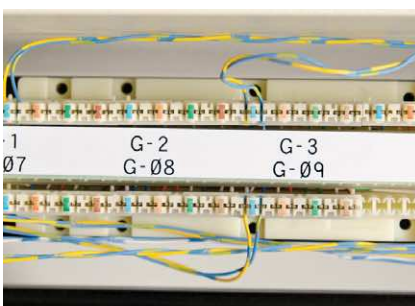

Terminal block labels



Punch block & patch panel labels

General & industrial identification

Asset & component marking to be used on all kind of surfaces (smooth, rough, textured, low energy...).



Rating & name plate labels

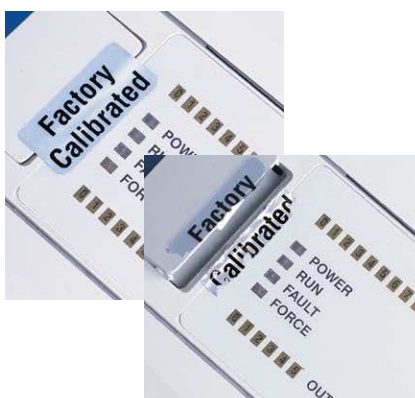

Security identification labels

Applications

Safety & facility identification



Pipe & valve marking



Food processing equipment marking



Exit & directional signs



Maintenance labels



Area & pathway marking



Safety signs and labels



Lean warehouse labels

Electronics identification

Circuit Board Marking for printed circuit board identification (also static dissipative), PCB SMT – Top/Bottom...

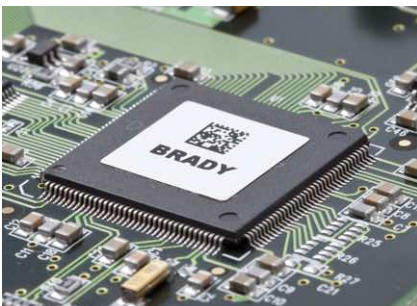

Polyester labels

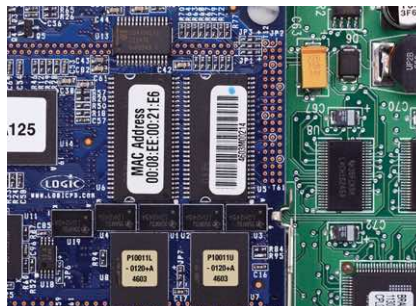

Polyimide labels

Applications

Laboratory identification

Specimen tracking identification for sample tracking within histology labs: use barcode technology to prevent misdiagnosis.



Straws & rods



Vial top labels



Vial & tube labels



Conical & large tube labels

Specimen process marking supporting microscopic analysis of cells and tissues within pathology and clinical labs.



Centrifuge/microcentrifuge labels



Slide labels

Specimen storage identification supporting specimen collection and handling such as blood samples, cryo-samples etc.



Cryo labels



Tissue cassette labels



Well plate labels

Lean lab identification for general supplies marking.



Bottle tamper seals



Bottles, flasks & dishes



General lab equipment labels

Advantages of labelling

Ever lost time figuring out where each wire goes?

Durable professional labels that remain legible and stay attached in harsh conditions are extremely important to keep power, network, voice and data cables and components organised and running effectively.

Professional identification on wires, cables and components enables you to:

- immediately recognise what needs checking during troubleshooting
- clearly mark parts for upcoming maintenance upgrades
- trace history, lifespan and supplier
- add safety warnings or precautions

Ask yourself how much time or money you lose while trying to trace an unidentified faulty cable, wire or component.

Ask yourself how fast pressure builds when machinery, production lines, servers and services are impacted.

This is when professional labelling pays off big time.

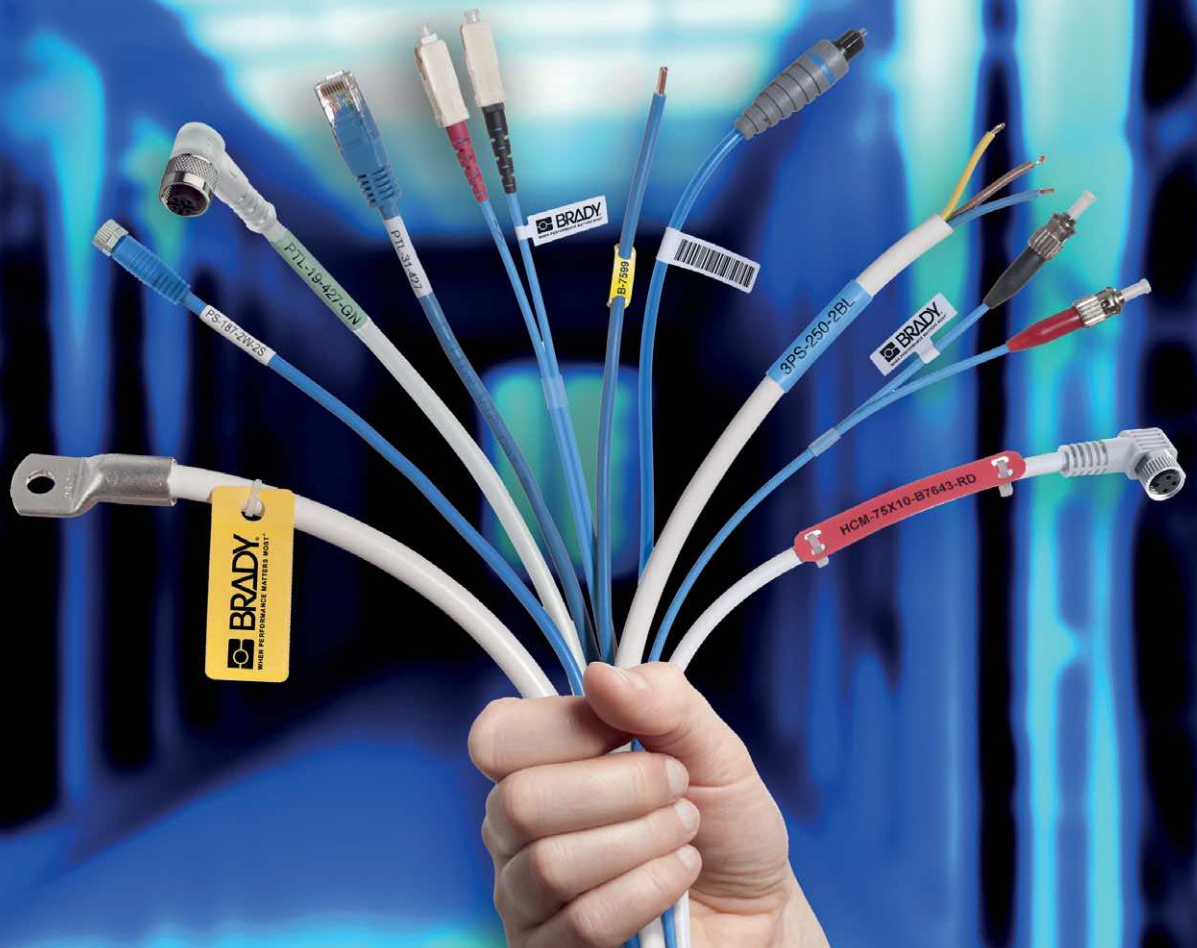

What is a professional label?

The combination of label liner, adhesive, substrate and topcoat provide a professional label's features, resistances, capabilities and durability.

- 1** The topcoat gives the label its colour and finish, receives the print, and increases resistance against weathering, flames, chemicals or heat.
- 2** The substrate gives the label its form and provides tensile properties such as strength and flexibility and physical properties such as chemical and temperature resistance.
- 3** The adhesive attaches the label to a chosen surface type and ensures resistance against a set of environmental contexts.
- 4** The label liner is a very thin carrier that releases the self-adhesive label.

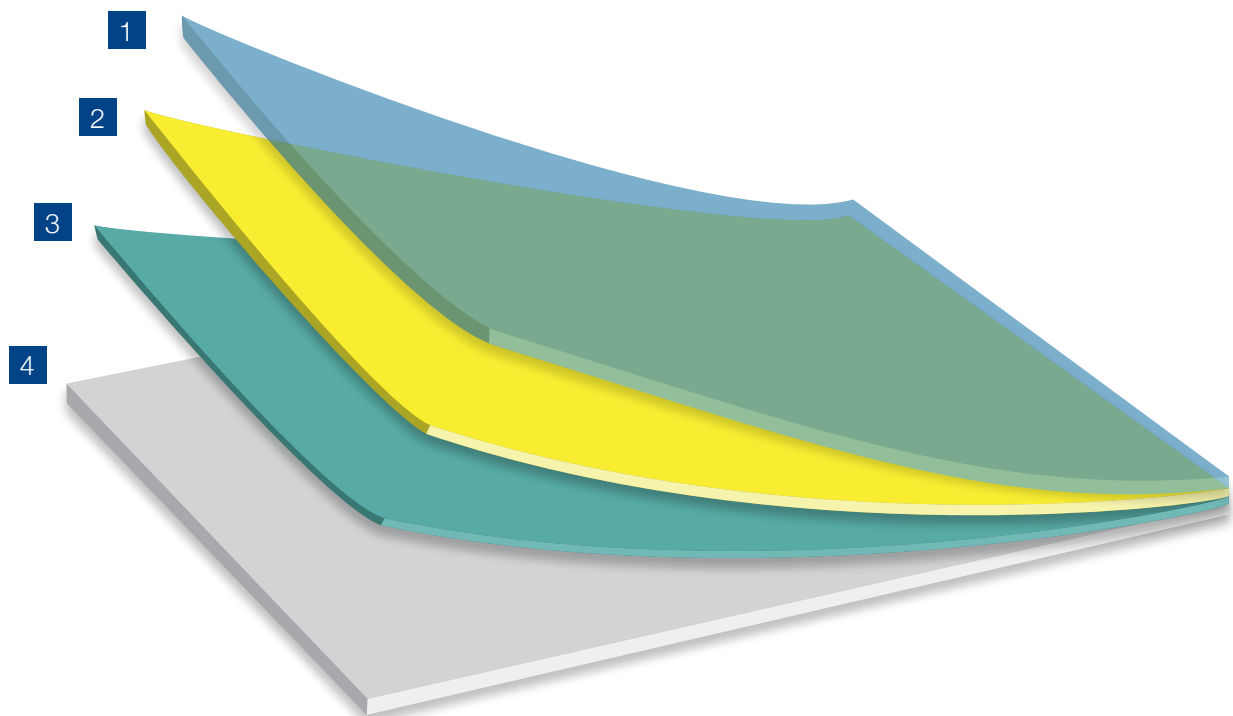

Which label suits your needs best?

Request your Electrical, Tele- & Datacom Identification guide book to help you choose the optimal Brady label material for your application at:

www.bradyeurope.com/cableID.

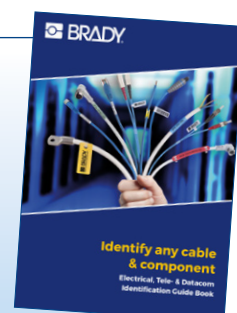

BMP71 media offering

We continuously try to improve & extend our label material offering, therefore make sure to check for firmware upgrades regularly, in order to make sure you always have access to the newest materials.

Material	
B-109	Polyethylene Tag
B-145	Polyethylene Tag
B-342	Heat-shrink Polyolefin Sleeve
B-351	Tamper-resistant Vinyl
B-362	Tamper-resistant Metallised Vinyl
B-403	Paper
B-412	Polypropylene Tag
B-414	Polyester
B-422	Polyester
B-423	Polyester
B-424	Paper
B-425A	Polypropylene
B-427	Self-laminating Vinyl
B-428	Metallised Polyester
B-430	Polyester
B-437	Polyvinylfluoride
B-459	Polyester
B-461	Self-laminating Polyester
B-472	Polyimide
B-473	Static Dissipative Polyester
B-481	StainerBondz™ Polyester
B-483A	Polyester
B-483A/B-634	Polyester with Polyester Overlamine
B-486B	Metallised Polyester
B-488	Polyester
B-489A	Polyester

Material	
B-490	Freezerbondz™ Polyester
B-492	Freezerbondz™ Polyester
B-498	Vinyl Cloth
B-499	Nylon Cloth
B-529	Polypropylene
B-530	Tamper-resistant Vinyl
B-582	Phosphorescent Polyester
B-584	Reflective Tape
B-595	Vinyl
B-642	Polyvinylfluoride
B-717	Polyimide
B-718	Polyimide
B-719	Polyimide
B-724	Polyimide
B-727	Polyimide
B-7593	Polyethylene Foam Laminate Polyester
B-7598	Polyester Tag
B-7599	Polyethylene Tag
B-7641	Heat-shrink Polyolefin Sleeve
B-7643	Thermoplastic Polyether Polyurethane
B-7696	Vinyl Tag
B-7697	Polyester
B-854	Metal Detectable Polyester
B-855	Polyester

Compatible consumables



Most of the BMP61 consumables are compatible with the BMP71 Label Printer by using the black media guide provided with the BMP71. Extra media guides are available as an accessory (order ref.: M71-ADAPT-BK)



Bulk packaging for high volume printing



Bulk labels are designed as a cost-effective solution for high volume labelling needs. Order references beginning with 'B' indicate bulk rolls. Bulk Label printing requires the media feeder and smart cell spool which are included in the bulk label material packaging.



Get your custom BMP71 labels according to your specifications!

Frequently used custom labels include:

- Specific shapes and/or dimensions
- Specific colouring: material appearance through label colouring
- Specific materials to meet your requirements: chemical resistance, UV resistance, scratch resistance
- Specific printing or layout



Ribbons

All materials in the printer work with a series of M71 ribbons that easily fit into the printer. It is recommended to insert the ribbon before loading the consumable.

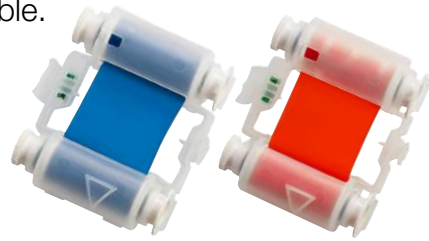

▶ Watch the how-to videos on our Brady YouTube channel.



Order Reference	Colour	Roll Width (mm)	Roll Length (m)	Formulation	Notes / Details
M71-R10000	Black	50.00	45.72	Resin	Featuring a 5-second "drop and click" supply change, this smear-proof BMP®71 Ribbon needs no threading or calibration. And, it's built super-tough for outdoor and industrial use.
M71-R10000-BL	Blue	50.00	45.72	Resin	Featuring a 5-second "drop and click" supply change, this smear-proof BMP®71 Ribbon needs no threading or calibration. And, it's built super-tough for outdoor and industrial use.
M71-R10000-GN	Green	50.00	45.72	Resin	Featuring a 5-second "drop and click" supply change, this smear-proof BMP®71 Ribbon needs no threading or calibration. And, it's built super-tough for outdoor and industrial use.
M71-R10000-MA	Magenta	50.00	45.72	Resin	Featuring a 5-second "drop and click" supply change, this smear-proof BMP®71 Ribbon needs no threading or calibration. And, it's built super-tough for outdoor and industrial use.
M71-R10000-RD	Red	50.00	45.72	Resin	Featuring a 5-second "drop and click" supply change, this smear-proof BMP®71 Ribbon needs no threading or calibration. And, it's built super-tough for outdoor and industrial use.
M71-R10000-WT	White	50.00	45.72	Resin	Featuring a 5-second "drop and click" supply change, this smear-proof BMP®71 Ribbon needs no threading or calibration. And, it's built super-tough for outdoor and industrial use.
M71-R10000-YL	Yellow	50.00	45.72	Resin	Featuring a 5-second "drop and click" supply change, this smear-proof BMP®71 Ribbon needs no threading or calibration. And, it's built super-tough for outdoor and industrial use.
M71-R4400-WT	White	50.00	45.72	Resin	High density ribbon with excellent solvent resistance, high heat resistance, and super scratch resistance.
M71-R6000	Black	50.00	45.72	Resin	High density ribbon, excellent solvent resistance, high heat resistance, and super scratch resistance.
M71-R6200	Black	50.00	45.72	Resin	Designed for harsh environment labelling applications. Superior abrasion, chemical and heat resistance.
M71-R6400	Black	50.00	45.72	Resin	Ultra high chemical resistance at high temperatures. Superior solvent resistance.
M71-R6600	Black	50.00	45.72	Resin	Diesel resistant ribbon for thermal printing on Brady PermaSleeve and Heatex Sleeves. This ribbon has with excellent chemical and abrasion resistance
M71-R6800-WT	White	50.00	36.58	Resin	Strong environmental resistance against smearing and chemicals. Also, reliable, sharp-edge print quality to maximise bar code readability.
M71-R6900-BL	Blue	50.00	45.72	Resin	High density ribbon with excellent solvent resistance, high heat resistance, and super scratch resistance.
M71-R6900-GN	Green	50.00	45.72	Resin	High density ribbon with excellent solvent resistance, high heat resistance, and super scratch resistance.
M71-R6900-MA	Magenta	50.00	45.72	Resin	High density ribbon with excellent solvent resistance, high heat resistance, and super scratch resistance.
M71-R6900-RD	Red	50.00	45.72	Resin	High density ribbon with excellent solvent resistance, high heat resistance, and super scratch resistance.
M71-R6900-YL	Yellow	50.00	45.72	Resin	High density ribbon with excellent solvent resistance, high heat resistance, and super scratch resistance.
M71-R4300	Black	50.00	45.72	Wax/Resin	Strong environmental resistance against smearing and chemicals. Also, reliable, sharp-edge print quality to maximise bar code readability.
M71-R6700-WT	White	50.00	45.72	Wax/Resin	The White 6700 Series Thermal Transfer Ribbon offers high performance against scratching, smudging, and harsh chemicals. The ribbon can be used for printing on Brady's Black PermaSleeve™ materials

▶ Smart-Cell Technology

With smart-cell technology built into label rolls and ribbons, the printer is able to automatically format the label and place objects so that there is no guess work on your part. If the label material & ribbon are not compatible, the screen will show an error message.



Wire & cable marking



PermaSleeve heat-shrink sleeve markers

- These heat-shrink sleeves are the ultimate in marker identification, protection, durability and aesthetic appearance.
- Fast shrink rate saves time and costs during installation.

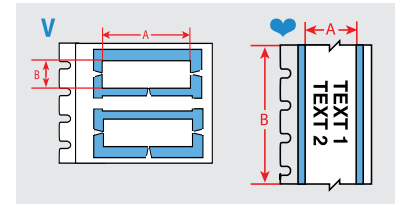

Diagram	Order Reference	Shrink Ratio	Colour	Sleeve Width A (mm)	Sleeve Height B (mm)	Min. Wire Diameter (mm)	Max. Wire Diameter (mm)	Sleeves per roll	Printer Ribbon Series	Printer Compatibility
B-342: Heat-shrink Polyolefin										
♥	BM71C-125-342	3:1	White	6.00	-	1.17	2.79	1	M71-R4300	BMP71
♥	BM71C-187-342	3:1	White	8.50	-	1.57	3.81	1	M71-R4300	BMP71
♥	BM71C-250-342	3:1	White	11.15	-	2.39	5.46	1	M71-R4300	BMP71
♥	BM71C-375-342	3:1	White	16.40	-	3.18	8.13	1	M71-R4300	BMP71
♥	BM71C-500-342	3:1	White	21.60	-	4.75	11.43	1	M71-R4300	BMP71
♥	BM71C-1000-342	3:1	White	42.16	-	9.53	24.13	1	M71-R4300	BMP71
V	BM71-94-1-342-2	3:1	White	12.70	4.60	0.58	2.03	5000	R4300	M611, BMP61, BMP71
V	BM71-94-175-342-2	3:1	White	22.22	4.60	0.58	2.03	5000	R4300	M611, BMP61, BMP71
V	BM71-94-1-342	3:1	White	25.78	4.60	0.58	2.03	2500	R4300	M611, BMP61, BMP71
V	M71-94-1-342YL	3:1	Yellow	25.78	4.60	0.58	2.03	100	M71-R4300	BMP71
V	BM71-94-1-342YL	3:1	Yellow	25.78	4.60	0.58	2.03	2500	R4300	M611, BMP61, BMP71
V	M71-94-175-342	3:1	White	44.83	4.60	0.58	2.03	100	M71-R4300	BMP71
V	BM71-94-175-342	3:1	White	44.83	4.60	0.58	2.03	2500	R4300	M611, BMP61, BMP71
V	M71-94-175-342YL	3:1	Yellow	44.83	4.60	0.58	2.03	100	M71-R4300	BMP71
V	BM71-94-175-342YL	3:1	Yellow	44.83	4.60	0.58	2.03	2500	R4300	M611, BMP61, BMP71
V	M71-94-1-342	3:1	White	25.78	4.62	0.58	2.03	100	M71-R4300	BMP71
V	BM71-125-1-342-2	3:1	White	12.70	6.00	1.17	2.79	2000	R4300	M611, BMP61, BMP71
V	BM71-125-175-342-3	3:1	White	14.81	6.00	1.17	2.79	3000	R4300	M611, BMP61, BMP71
V	BM71-125-175-342-2	3:1	White	22.22	6.00	1.17	2.79	2000	R4300	M611, BMP61, BMP71
V	BM71-125-1-342-YL	3:1	Yellow	25.40	6.00	1.17	2.79	1000	R4300	M611, BMP61, BMP71
V	BM71-125-1-342	3:1	White	25.78	6.00	1.17	2.79	1000	R4300	M611, BMP61, BMP71
V	M71-125-1-342	3:1	White	25.78	6.00	1.17	2.79	100	M71-R4300	BMP71
V	M71-125-1-342YL	3:1	Yellow	25.78	6.00	1.17	2.79	100	M71-R4300	BMP71
V	M71-125-175-342	3:1	White	44.83	6.00	1.17	2.79	100	M71-R4300	BMP71
V	BM71-125-175-342	3:1	White	44.83	6.00	1.17	2.79	1000	R4300	M611, BMP61, BMP71
V	M71-125-175-342YL	3:1	Yellow	44.83	6.00	1.17	2.79	100	M71-R4300	BMP71
V	BM71-125-175-342YL	3:1	Yellow	44.83	6.00	1.17	2.79	1000	R4300	M611, BMP61, BMP71
V	BM71-187-175-342-4	3:1	White	11.10	8.50	1.57	3.81	4000	R4300	M611, BMP61, BMP71
V	BM71-187-1-342-2	3:1	White	12.70	8.50	1.57	3.81	2000	R4300	M611, BMP61, BMP71
V	BM71-187-175-342-3	3:1	White	14.81	8.50	1.57	3.81	3000	R4300	M611, BMP61, BMP71
V	BM71-187-175-342-2	3:1	White	22.22	8.50	1.57	3.81	2000	R4300	M611, BMP61, BMP71
V	M71-187-1-342	3:1	White	25.78	8.50	1.57	3.81	100	M71-R4300	BMP71
V	BM71-187-1-342	3:1	White	25.78	8.50	1.57	3.81	1000	R4300	M611, BMP61, BMP71

Order references beginning with "B" indicate bulk rolls.

>>

Wire & cable marking

PermaSleeve heat-shrink sleeve markers (continued)

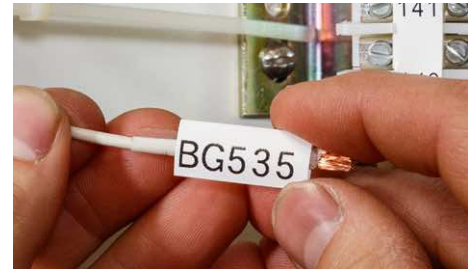
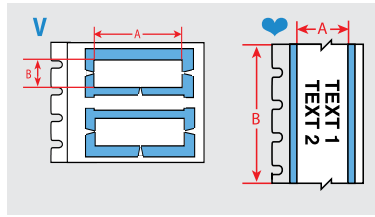
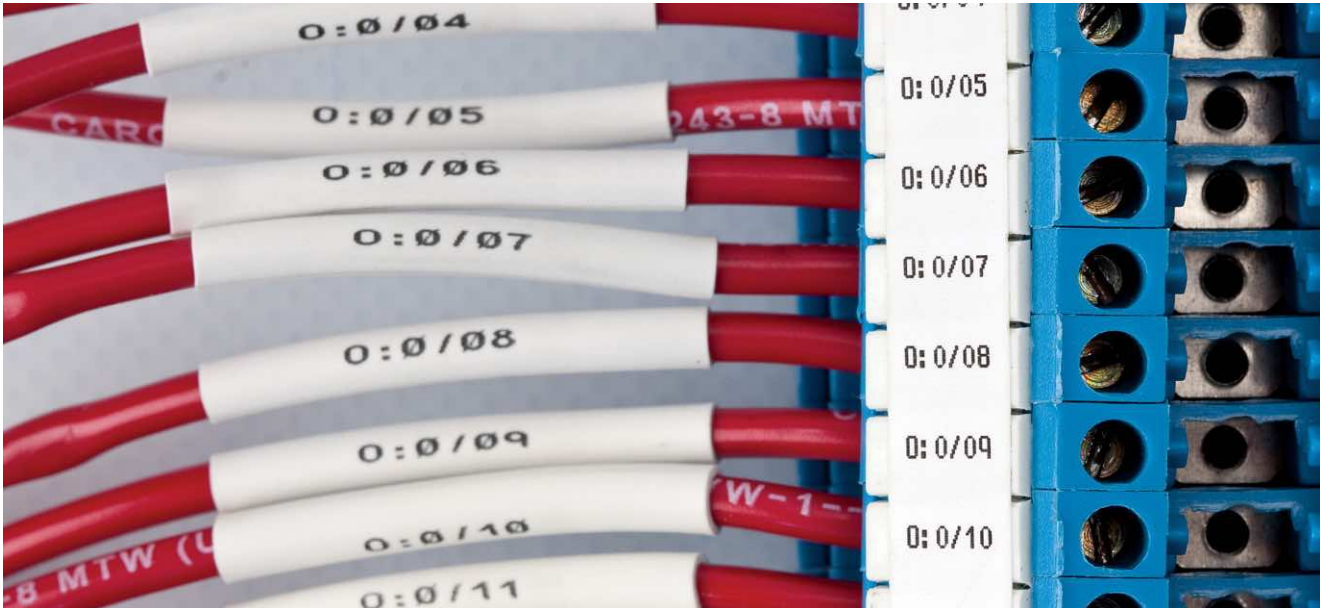

Diagram	Order Reference	Shrink Ratio	Colour	Sleeve Width A (mm)	Sleeve Height B (mm)	Min. Wire Diameter (mm)	Max. Wire Diameter (mm)	Sleeves per roll	Printer Ribbon Series	Printer Compatibility
V	M71-187-1-342YL	3:1	Yellow	25.78	8.50	1.57	3.81	100	M71-R4300	BMP71
V	BM71-187-1-342-YL	3:1	Yellow	25.78	8.50	1.57	3.81	1000	R4300	M611, BMP61, BMP71
V	BM71-187-175-342OR	3:1	Orange	44.45	8.50	1.57	3.81	1000	R4300	M611, BMP61, BMP71
V	BM71-187-175-342RD	3:1	Red	44.45	8.50	1.57	3.81	1000	R4300	M611, BMP61, BMP71
V	BM71-187-175-342	3:1	White	44.83	8.50	1.57	3.81	1000	R4300	M611, BMP61, BMP71
V	M71-187-175-342	3:1	White	44.83	8.50	1.57	3.81	100	M71-R4300	BMP71
V	M71-187-175-342YL	3:1	Yellow	44.83	8.50	1.57	3.81	100	M71-R4300	BMP71
V	BM71-187-175-342YL	3:1	Yellow	44.83	8.50	1.57	3.81	1000	R4300	M611, BMP61, BMP71
V	BM71-250-1-342-YL	3:1	Yellow	25.40	11.15	2.39	5.46	1000	R4300	M611, BMP61, BMP71
V	BM71-250-1-342	3:1	White	25.78	11.15	2.39	5.46	1000	R4300	M611, BMP61, BMP71
V	M71-250-1-342	3:1	White	25.78	11.15	2.39	5.46	100	M71-R4300	BMP71
V	M71-250-1-342YL	3:1	Yellow	25.78	11.15	2.39	5.46	100	M71-R4300	BMP71
V	BM71-250-175-342RD	3:1	Red	44.45	11.15	2.39	5.46	1000	R4300	M611, BMP61, BMP71
V	BM71-250-175-342	3:1	White	44.83	11.15	2.39	5.46	1000	R4300	M611, BMP61, BMP71
V	M71-250-175-342	3:1	White	44.83	11.15	2.39	5.46	100	M71-R4300	BMP71
V	M71-250-175-342YL	3:1	Yellow	44.83	11.15	2.39	5.46	100	M71-R4300	BMP71
V	BM71-250-175-342YL	3:1	Yellow	44.83	11.15	2.39	5.46	1000	R4300	M611, BMP61, BMP71
V	BM71-375-1-342-2	3:1	White	12.70	16.40	3.18	8.13	2000	R4300	M611, BMP61, BMP71
V	BM71-375-175-342-2	3:1	White	22.22	16.40	3.18	8.13	2000	R4300	M611, BMP61, BMP71
V	M71-375-1-342	3:1	White	25.78	16.40	3.18	8.13	100	M71-R4300	BMP71
V	BM71-375-1-342	3:1	White	25.78	16.40	3.18	8.13	1000	R4300	M611, BMP61, BMP71
V	M71-375-1-342YL	3:1	Yellow	25.78	16.40	3.18	8.13	100	M71-R4300	BMP71
V	BM71-375-1-342-YL	3:1	Yellow	25.78	16.40	3.18	8.13	1000	R4300	M611, BMP61, BMP71
V	BM71-375-175-342YL	3:1	Yellow	44.45	16.40	3.18	8.13	1000	R4300	M611, BMP61, BMP71
V	M71-375-175-342	3:1	White	44.83	16.40	3.18	8.13	100	M71-R4300	BMP71
V	BM71-375-175-342	3:1	White	44.83	16.40	3.18	8.13	1000	R4300	M611, BMP61, BMP71
V	M71-375-175-342YL	3:1	Yellow	44.83	16.40	3.18	8.13	100	M71-R4300	BMP71
V	BM71-500-175-342Y3	3:1	Yellow	14.81	21.60	4.75	11.43	3000	R4300	M611, BMP61, BMP71
V	M71-500-1-342	3:1	White	25.78	21.60	4.75	11.43	100	M71-R4300	BMP71
V	BM71-500-1-342	3:1	White	25.78	21.60	4.75	11.43	1000	R4300	M611, BMP61, BMP71
V	M71-500-1-342YL	3:1	Yellow	25.78	21.60	4.75	11.43	100	M71-R4300	BMP71
V	BM71-500-1-342YL	3:1	Yellow	25.78	21.60	4.75	11.43	1000	R4300	M611, BMP61, BMP71
V	BM71-500-175-342RD	3:1	Red	44.45	21.60	4.75	11.43	1000	M71-R4300	M611, BMP61, BMP71
V	M71-500-175-342	3:1	White	44.83	21.60	4.75	11.43	100	M71-R4300	BMP71
V	BM71-500-175-342	3:1	White	44.83	21.60	4.75	11.43	1000	R4300	M611, BMP61, BMP71
V	M71-500-175-342YL	3:1	Yellow	44.83	21.60	4.75	11.43	100	M71-R4300	BMP71
V	BM71-500-175-342YL	3:1	Yellow	44.83	21.60	4.75	11.43	1000	R4300	M611, BMP61, BMP71
V	M71-1000-1-342	3:1	White	25.78	42.16	9.53	24.13	50	M71-R4300	BMP71
V	M71-1000-1-342YL	3:1	Yellow	25.78	42.16	9.53	24.13	50	M71-R4300	BMP71
V	BM71-1000-175-342	3:1	White	44.83	42.16	9.53	24.13	500	R4300	M611, BMP61, BMP71
V	M71-1000-175-342	3:1	White	44.83	42.16	9.53	24.13	50	M71-R4300	BMP71
V	M71-1000-175-342YL	3:1	Yellow	44.83	42.16	9.53	24.13	50	M71-R4300	BMP71

Order references beginning with "B" indicate bulk rolls.

▶ See pages 49 - 51 for a detailed material index.

Wire & cable marking



PermaSleeve low smoke zero halogen wire marking sleeves, 2:1 shrink ratio

- These heat-shrink sleeves are the ultimate in marker identification, protection, durability and aesthetic appearance.
- These low smoke zero halogen wire marking sleeves offer outstanding fire safety properties and minimal smoke emission.
- Fast shrink rate saves time and costs during installation. Available as individual die-cut markers or continuous cut-to-length tubing.

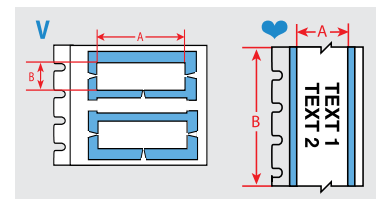

Sleeves are shown in order of sleeve height and per sleeve width.

Diagram	Order Reference	Shrink Ratio	Colour	Sleeve Width A (mm)	Sleeve Height B (mm)	Min. Wire Diameter (mm)	Max. Wire Diameter (mm)	Sleeves per roll	Printer Ribbon Series	Printer Compatibility
B-7641: Heat-shrink Polyolefin										
V	M71-94-1-7641	2:1	White	25.40	4.60	1.19	2.03	100	M71-R6600	BMP71
V	BM71-94-1-7641	2:1	White	25.40	4.60	1.19	2.03	2500	M71-R6600	BMP71
V	M71-94-1-7641Y	2:1	Yellow	25.40	4.60	1.19	2.03	100	M71-R6600	BMP71
V	BM71-94-1-7641Y	2:1	Yellow	25.40	4.60	1.19	2.03	2500	M71-R6600	BMP71
V	M71-94-175-7641	2:1	White	44.45	4.60	1.19	2.03	100	M71-R6600	BMP71
V	BM71-94-175-7641	2:1	White	44.45	4.60	1.19	2.03	2500	M71-R6600	BMP71
V	M71-94-175-7641Y	2:1	Yellow	44.45	4.60	1.19	2.03	100	M71-R6600	BMP71
V	BM71-94-175-7641Y	2:1	Yellow	44.45	4.60	1.19	2.03	2500	M71-R6600	BMP71
V	M71-125-1-7641	2:1	White	25.40	6.00	1.57	2.80	100	M71-R6600	BMP71
V	BM71-125-1-7641	2:1	White	25.40	6.00	1.57	2.80	1000	M71-R6600	BMP71
V	M71-125-1-7641Y	2:1	Yellow	25.40	6.00	1.57	2.80	100	M71-R6600	BMP71
V	BM71-125-1-7641Y	2:1	Yellow	25.40	6.00	1.57	2.80	1000	M71-R6600	BMP71
V	M71-125-175-7641	2:1	White	44.45	6.00	1.57	2.80	100	M71-R6600	BMP71
V	BM71-125-175-7641	2:1	White	44.45	6.00	1.57	2.80	1000	M71-R6600	BMP71
V	M71-125-175-7641YL	2:1	Yellow	44.45	6.00	1.57	2.80	100	M71-R6600	BMP71
V	BM71-125-175-7641Y	2:1	Yellow	44.45	6.00	1.57	2.80	1000	M71-R6600	BMP71
V	M71-187-1-7641	2:1	White	25.40	8.50	2.39	3.81	100	M71-R6600	BMP71
V	BM71-187-1-7641	2:1	White	25.40	8.50	2.39	3.81	1000	M71-R6600	BMP71
V	M71-187-1-7641Y	2:1	Yellow	25.40	8.50	2.39	3.81	100	M71-R6600	BMP71
V	BM71-187-1-7641Y	2:1	Yellow	25.40	8.50	2.39	3.81	1000	M71-R6600	BMP71
V	M71-187-175-7641	2:1	White	44.45	8.50	2.39	3.81	100	M71-R6600	BMP71

Order references beginning with "B" indicate bulk rolls.

>>

Wire & cable marking

PermaSleeve low smoke zero halogen wire marking sleeves, 2:1 shrink ratio (continued)

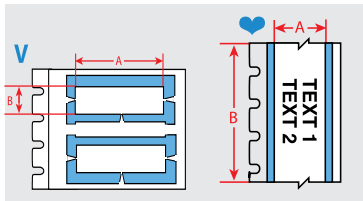

Diagram	Order Reference	Shrink Ratio	Colour	Sleeve Width A (mm)	Sleeve Height B (mm)	Min. Wire Diameter (mm)	Max. Wire Diameter (mm)	Sleeves per roll	Printer Ribbon Series	Printer Compatibility
V	BM71-187-175-7641	2:1	White	44.45	8.50	2.39	3.81	1000	M71-R6600	BMP71
V	M71-187-175-7641YL	2:1	Yellow	44.45	8.50	2.39	3.81	100	M71-R6600	BMP71
V	BM71-187-175-7641Y	2:1	Yellow	44.45	8.50	2.39	3.81	1000	M71-R6600	BMP71
V	M71-250-1-7641	2:1	White	25.40	11.15	3.18	5.46	100	M71-R6600	BMP71
V	BM71-250-1-7641	2:1	White	25.40	11.15	3.18	5.46	1000	M71-R6600	BMP71
V	M71-250-1-7641Y	2:1	Yellow	25.40	11.15	3.18	5.46	100	M71-R6600	BMP71
V	BM71-250-1-7641Y	2:1	Yellow	25.40	11.15	3.18	5.46	1000	M71-R6600	BMP71
V	M71-250-175-7641	2:1	White	44.45	11.15	3.18	5.46	100	M71-R6600	BMP71
V	BM71-250-175-7641	2:1	White	44.45	11.15	3.18	5.46	1000	M71-R6600	BMP71
V	M71-250-175-7641YL	2:1	Yellow	44.45	11.15	3.18	5.46	100	M71-R6600	BMP71
V	BM71-250-175-7641Y	2:1	Yellow	44.45	11.15	3.18	5.46	1000	M71-R6600	BMP71
V	BM71-375-1-7641	2:1	White	25.40	16.38	4.78	8.13	1000	M71-R6600	BMP71
V	BM71-375-1-7641Y	2:1	Yellow	25.40	16.38	4.78	8.13	1000	M71-R6600	BMP71
V	BM71-375-175-7641	2:1	White	44.45	16.38	4.78	8.13	1000	M71-R6600	BMP71
V	BM71-375-175-7641Y	2:1	Yellow	44.45	16.38	4.78	8.13	1000	M71-R6600	BMP71
V	M71-375-1-7641	2:1	White	25.40	16.40	4.78	8.13	100	M71-R6600	BMP71
V	M71-375-1-7641Y	2:1	Yellow	25.40	16.40	4.78	8.13	100	M71-R6600	BMP71
V	M71-375-175-7641	2:1	White	44.45	16.40	4.78	8.13	100	M71-R6600	BMP71
V	M71-375-175-7641Y	2:1	Yellow	44.83	16.40	4.78	8.13	100	M71-R6600	BMP71
V	M71-500-1-7641	2:1	White	25.40	21.60	6.35	11.43	100	M71-R6600	BMP71
V	BM71-500-1-7641	2:1	White	25.40	21.60	6.35	11.43	600	M71-R6600	BMP71
V	M71-500-1-7641Y	2:1	Yellow	25.40	21.60	6.35	11.43	100	M71-R6600	BMP71
V	BM71-500-1-7641Y	2:1	Yellow	25.40	21.60	6.35	11.43	600	M71-R6600	BMP71
V	M71-500-175-7641	2:1	White	44.45	21.60	6.35	11.43	100	M71-R6600	BMP71
V	BM71-500-175-7641	2:1	White	44.45	21.60	6.35	11.43	600	M71-R6600	BMP71
V	M71-500-175-7641YL	2:1	Yellow	44.45	21.60	6.35	11.43	100	M71-R6600	BMP71
V	BM71-500-175-7641Y	2:1	Yellow	44.45	21.60	6.35	11.43	600	M71-R6600	BMP71
V	M71-750-1-7641	2:1	White	25.40	31.75	9.53	17.78	75	M71-R6600	BMP71
V	BM71-750-1-7641	2:1	White	25.40	31.75	9.53	17.78	600	M71-R6600	BMP71
V	M71-750-1-7641Y	2:1	Yellow	25.40	31.75	9.53	17.78	75	M71-R6600	BMP71
V	BM71-750-1-7641Y	2:1	Yellow	25.40	31.75	9.53	17.78	600	M71-R6600	BMP71
V	M71-750-175-7641	2:1	White	44.45	31.75	9.53	17.78	75	M71-R6600	BMP71
V	BM71-750-175-7641	2:1	White	44.45	31.75	9.53	17.78	600	M71-R6600	BMP71
V	M71-750-175-7641YL	2:1	Yellow	44.45	31.75	9.53	17.78	75	M71-R6600	BMP71
V	BM71-750-175-7641Y	2:1	Yellow	44.45	31.75	9.53	17.78	600	M71-R6600	BMP71

Order references beginning with "B" indicate bulk rolls.

▶ See pages 49 - 51 for a detailed material index.

Wire & cable marking



Self-laminating labels

- Features a clear, non-printable area that wraps around the cable and serves as an overlamine to the printed text.
- Offers superior resistance to abrasion, dirt, oils, solvents and water.

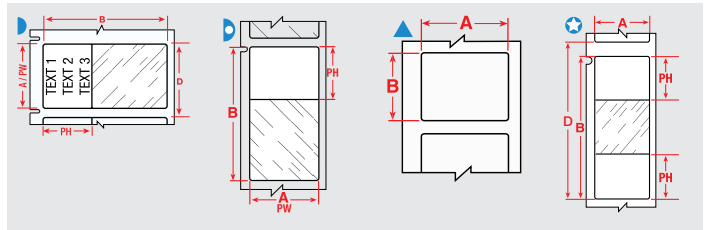

Diagram	Order Reference	Colour	Label Width A (mm)	Label Height B (mm)	Printable Area Width PW (mm)	Printable Area Height PH (mm)	Vertical Repeat D (mm)	Min. Wire Diameter (mm)	Max. Wire Diameter (mm)	Labels per Roll	Printer Ribbon Series	Printer Compatibility
B-427: Self-laminating Vinyl												
▶	M71-10-427	White, Transparent	6.35	19.05	6.35	9.53	9.53	2.00	3.00	750	M71-R4300	BMP71
▶	M71-28-427	White, Transparent	6.35	38.10	6.35	12.70	9.53	4.00	8.10	750	M71-R4300	BMP71
▶	BM71-11-427	White, Transparent	12.70	19.05	12.70	9.53	15.88	2.00	3.00	5000	R4300	M611, BMP61, BMP71
▶	M71-11-427	White, Transparent	12.70	19.05	12.70	9.53	15.88	2.00	3.00	500	M71-R4300	BMP71
▶	BM71-17-427	White, Transparent	12.70	25.40	12.70	9.53	15.88	2.70	5.10	5000	R4300	M611, BMP61, BMP71
▶	M71-17-427	White, Transparent	12.70	25.40	12.70	9.53	15.88	2.70	5.10	500	M71-R4300	BMP71
▶	M71-29-427	White, Transparent	12.70	38.10	12.70	12.70	15.88	4.00	8.10	500	M71-R4300	BMP71
▶	BM71-29-427	White, Transparent	12.70	38.10	12.70	12.70	15.88	4.00	8.10	5000	R4300	M611, BMP61, BMP71
▶	BM71-18-427	White, Transparent	19.05	25.40	19.05	9.53	22.23	2.70	5.10	2500	R4300	M611, BMP61, BMP71
▶	M71-18-427	White, Transparent	19.05	25.40	19.05	9.53	22.23	2.70	5.10	250	M71-R4300	BMP71
▶	M71-30-427	White, Transparent	19.05	38.10	19.05	12.70	22.23	4.00	8.10	250	M71-R4300	BMP71
▶	BM71-30-427	White, Transparent	19.05	38.10	19.05	12.70	22.23	4.00	8.10	2500	R4300	M611, BMP61, BMP71
▶	M71-30-427-BL	Blue, Transparent	19.05	38.10	19.05	12.70	22.23	4.00	8.10	250	M71-R4300	BMP71
▶	M71-30-427-PL	Purple, Transparent	19.05	38.10	19.05	12.70	22.23	4.00	8.10	250	M71-R4300	BMP71
▶	M71-30-427-RD	Red, Transparent	19.05	38.10	19.05	12.70	22.23	4.00	8.10	250	M71-R4300	BMP71
▶	M71-96-427	White, Transparent	25.40	19.05	25.40	9.53	22.23	2.00	3.00	250	M71-R4300	BMP71
▶	M71-19-427-YL	Yellow, Transparent	25.40	25.40	25.40	9.53	28.58	2.70	5.10	250	M71-R4300	BMP71
▶	M71-19-427	White, Transparent	25.40	25.40	25.40	9.53	28.58	2.70	5.10	250	M71-R4300	BMP71
▶	BM71-19-427	White, Transparent	25.40	25.40	25.40	9.53	28.58	2.70	5.10	2500	R4300	M611, BMP61, BMP71
▶	M71-103-427	White, Transparent	25.40	31.75	25.40	12.70	34.93	3.40	6.10	250	M71-R4300	BMP71
▶	M71-31-427-YL	Yellow, Transparent	25.40	38.10	25.40	12.70	28.58	4.00	8.10	250	M71-R4300	BMP71
▶	BM71-31-427	White, Transparent	25.40	38.10	25.40	12.70	28.58	4.00	8.10	2500	R4300	M611, BMP61, BMP71
▶	M71-31-427-GN	Green, Transparent	25.40	38.10	25.40	12.70	28.58	4.00	8.10	250	M71-R4300	BMP71
▶	M71-31-427-RD	Red, Transparent	25.40	38.10	25.40	12.70	28.58	4.00	8.10	250	M71-R4300	BMP71
▶	M71-31-427	White, Transparent	25.40	38.10	25.40	12.70	28.58	4.00	8.10	250	M71-R4300	BMP71
▶	BM71-21-427	White, Transparent	25.40	63.50	25.40	19.05	66.68	6.70	14.20	1000	R4300	M611, BMP61, BMP71
▶	M71-21-427-YL	Yellow, Transparent	25.40	63.50	25.40	19.05	66.68	6.70	14.20	100	M71-R4300	BMP71
▶	M71-21-427	White, Transparent	25.40	63.50	25.40	19.05	66.68	6.70	14.20	100	M71-R4300	BMP71
★	BM71-64-427	White, Transparent	25.40	85.73	25.40	28.58	88.90	9.10	18.20	1000	R4300	M611, BMP61, BMP71

Order references beginning with "B" indicate bulk rolls. *Order references ending with "AW" indicate all white labels with no clear area.

>>

Wire & cable marking

Self-laminating labels (continued)

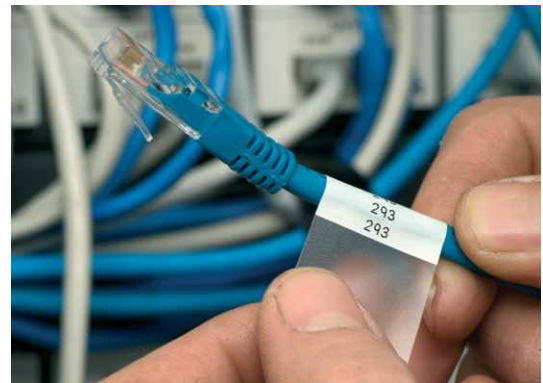
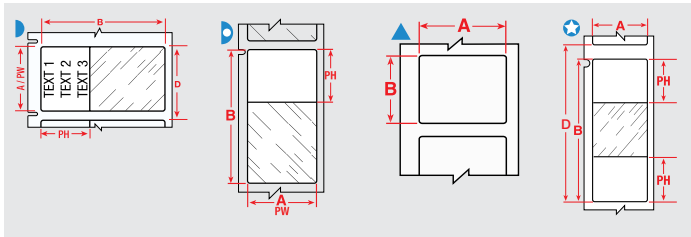
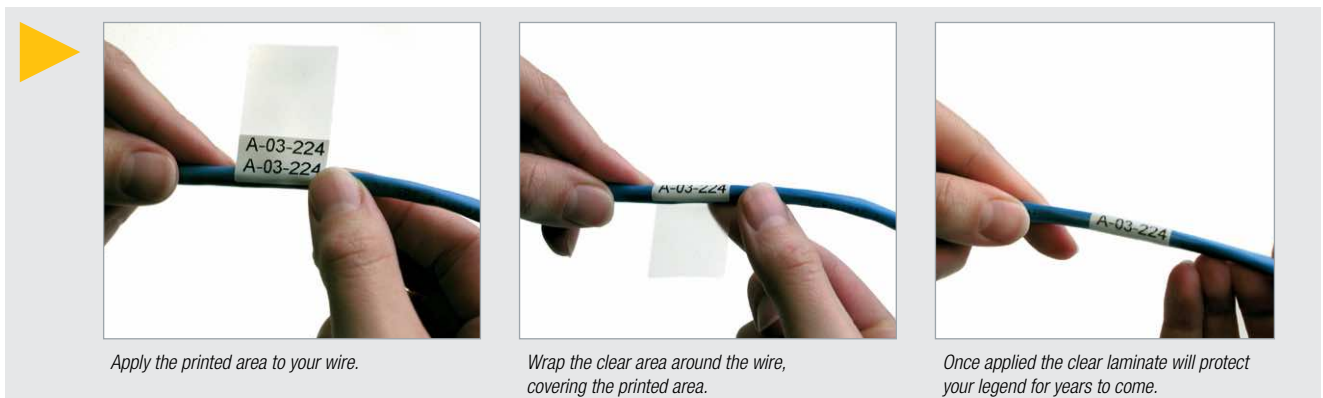

Diagram	Order Reference	Colour	Label Width A (mm)	Label Height B (mm)	Printable Area Width PW (mm)	Printable Area Height PH (mm)	Vertical Repeat D (mm)	Min. Wire Diameter (mm)	Max. Wire Diameter (mm)	Labels per Roll	Printer Ribbon Series	Printer Compatibility
★	M71-64-427	White, Transparent	25.40	85.73	25.40	28.58	88.90	9.10	18.20	100	M71-R4300	BMP71
▷	BM71-23-427	White, Transparent	25.40	101.60	25.40	25.40	104.78	10.80	24.30	1000	R4300	M611, BMP61, BMP71
▷	M71-23-427	White, Transparent	25.40	101.60	25.40	25.40	104.78	10.80	24.30	100	M71-R4300	BMP71
▲	M71-30-427-AW	White	38.10	19.05	38.10	19.05	22.23	4.00	8.00	250	M71-R4300	BMP71
▷	M71-104-427	White, Transparent	38.10	25.40	38.10	9.53	28.58	2.70	5.10	250	M71-R4300	BMP71
▷	BM71-32-427	White, Transparent	38.10	38.10	38.10	12.70	41.28	4.00	8.10	1000	R4300	M611, BMP61, BMP71
▷	M71-32-427-YL	Yellow, Transparent	38.10	38.10	38.10	12.70	41.28	4.00	8.10	250	M71-R4300	BMP71
▷	M71-32-427	White, Transparent	38.10	38.10	38.10	12.70	41.28	4.00	8.10	250	M71-R4300	BMP71
▷	M71-33-427-YL	Yellow, Transparent	38.10	101.60	38.10	25.40	104.78	10.80	24.30	100	M71-R4300	BMP71
▷	BM71-33-427	White, Transparent	38.10	101.60	38.10	25.40	104.78	10.80	24.30	500	R4300	M611, BMP61, BMP71
▷	M71-109-427	White, Transparent	38.10	101.60	38.10	38.10	104.78	10.80	20.20	100	M71-R4300	BMP71
▷	BM71-109-427	White, Transparent	38.10	101.60	38.10	38.10	104.78	10.80	20.20	500	R4300	M611, BMP61, BMP71
▷	M71-33-427	White, Transparent	38.10	101.60	38.10	25.40	104.78	10.80	24.30	100	M71-R4300	BMP71
▷	M71-34-427	White, Transparent	38.10	152.40	38.10	38.10	155.58	16.20	36.40	50	M71-R4300	BMP71
▷	BM71-34-427	White, Transparent	38.10	152.40	38.10	38.10	155.58	16.20	36.40	500	R4300	M611, BMP61, BMP71
▷	M71-88-427	White, Transparent	44.45	38.10	44.45	12.70	41.28	4.00	8.10	250	M71-R4300	BMP71
▷	M71-66-427	White, Transparent	49.28	80.00	49.23	25.40	83.57	8.50	17.40	100	M71-R4300	BMP71
▷	M71-107-427	White, Transparent	50.80	38.10	50.80	12.70	53.98	4.00	8.10	100	M71-R4300	BMP71
▷	BM71-107-427	White, Transparent	50.80	38.10	50.80	12.70	53.98	4.00	8.10	1000	R4300	M611, BMP61, BMP71
B-642: Polyvinylfluoride												
▷	M71-19-642	White, Transparent	25.40	25.40	25.40	9.53	28.58	3.00	5.00	250	M71-R4300	BMP71
▷	M71-31-642	White, Transparent	25.40	38.10	25.40	12.70	28.58	4.00	8.00	250	M71-R4300	BMP71
▷	M71-21-642	White, Transparent	25.40	63.50	25.40	19.05	66.68	6.00	14.00	100	M71-R4300	BMP71

Order references beginning with "B" indicate bulk rolls. *Order references ending with "AW" indicate all white labels with no clear area.



Wire & cable marking



Wrap around labels

- These durable cloth wrap around labels are available with either an adhesive that allows the markers to be removed cleanly and reapplied if necessary (B-498) or with a permanent adhesive (B-437, B-499).
- A 3 mm overlap is recommended with these materials for an ideal, long lasting solution.

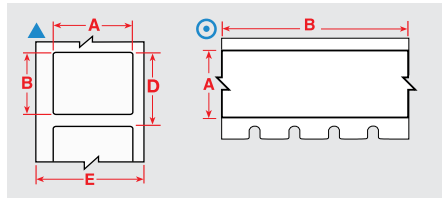

Diagram	Order Reference	Colour	Label Width A (mm)	Label Height B (mm)	Label Length B (m)	Vertical Repeat D (mm)	Max. Wire Diameter (mm)	Labels per Roll	Printer Ribbon Series	Printer Compatibility
B-472: Polyimide										
⊙	M71C-1000-472	White	25.40	-	15.24	-	-	1	M71-R4300, M71-R6200	BMP71
⊙	M71C-1000-472-YL	Yellow	25.40	-	15.24	-	-	1	M71-R4300, M71-R6200	BMP71
▲	M71-17-472	White	25.40	12.70	-	15.88	-	500	M71-R4300, M71-R6200	BMP71
⊙	M71C-1500-472	White	38.10	-	15.24	-	-	1	M71-R4300, M71-R6200	BMP71
⊙	M71C-1500-472-YL	Yellow	38.10	-	15.24	-	-	1	M71-R4300, M71-R6200	BMP71
▲	M71-30-472	White	38.10	19.05	-	22.23	-	250	M71-R4300, M71-R6200	BMP71
⊙	M71C-2000-472	White	50.80	-	15.24	-	-	1	M71-R4300, M71-R6200	BMP71
⊙	M71C-2000-472-YL	Yellow	50.80	-	15.24	-	-	1	M71-R4300, M71-R6200	BMP71
B-498: Vinyl Cloth										
⊙	BM71C-240-498	White	6.10	-	83.80	-	-	1	R6200	M611, BMP61, BMP71
⊙	M71C-240-498	White	6.10	-	9.14	-	-	1	M71-R6200	BMP71
▲	M71-10-498	White	6.35	19.05	-	9.53	4.55	750	M71-R6200	BMP71
⊙	BM71C-318-498	White	8.08	-	83.80	-	-	1	R6200	M611, BMP61, BMP71
⊙	M71C-318-498	White	8.08	-	9.14	-	-	1	M71-R6200	BMP71
⊙	M71C-375-498	White	9.53	-	9.14	-	-	1	M71-R6200	BMP71
⊙	BM71C-375-498	White	9.53	-	83.80	-	-	1	R6200	M611, BMP61, BMP71
▲	M71-16-498	White	9.53	25.40	-	12.70	6.06	500	M71-R6200	BMP71
⊙	M71C-500-498	White	12.70	-	9.10	-	-	1	M71-R6200	BMP71
▲	M71-7-498	White	12.70	12.70	-	15.88	3.03	500	M71-R6200	BMP71
▲	BM71-11-498	White	12.70	19.05	-	15.88	4.55	5000	R6200	M611, BMP61, BMP71
▲	M71-11-498	White	12.70	19.05	-	15.88	4.55	500	M71-R6200	BMP71
▲	BM71-29-498	White	12.70	38.10	-	15.88	9.10	5000	R6200	M611, BMP61, BMP71
▲	M71-18-498	White	19.05	25.40	-	22.23	6.06	250	M71-R6200	BMP71
▲	BM71-18-498	White	19.05	25.40	-	22.23	6.06	2500	R6200	M611, BMP61, BMP71
▲	M71-30-498	White	19.05	38.10	-	22.23	9.10	250	M71-R6200	BMP71
⊙	M71C-1000-498	White	25.40	-	9.10	-	-	1	M71-R6200	BMP71
▲	M71-17-498	White	25.40	12.70	-	15.88	6.06	500	M71-R6200	BMP71
▲	M71-19-498	White	25.40	25.40	-	28.58	6.06	250	M71-R6200	BMP71
▲	BM71-19-498	White	25.40	25.40	-	28.58	6.06	2500	R6200	M611, BMP61, BMP71
▲	M71-31-498	White	25.40	38.10	-	28.58	9.10	250	M71-R6200	BMP71
▲	M71-21-498	White	25.40	63.50	-	66.68	15.60	100	M71-R6200	BMP71
▲	M71-33-498	White	38.10	101.60	-	104.78	24.26	100	M71-R6200	BMP71
▲	M71-29-498	White	38.10	12.70	-	15.88	9.10	500	M71-R6200	BMP71
▲	M71-32-498	White	38.10	38.10	-	41.28	9.10	250	M71-R6200	BMP71
⊙	M71C-1900-498	White	48.26	-	9.10	-	-	1	M71-R6200	BMP71

Order references beginning with "B" indicate bulk rolls.

>>

▶ See pages 49 - 51 for a detailed material index.

Wire & cable marking

Wrap around labels (continued)

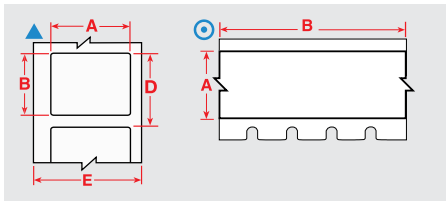

Diagram	Order Reference	Colour	Label Width A (mm)	Label Height B (mm)	Label Length B (m)	Vertical Repeat D (mm)	Max. Wire Diameter (mm)	Labels per Roll	Printer Ribbon Series	Printer Compatibility
B-499: Nylon Cloth										
▲	M71-16-499	White	9.53	25.40	-	12.70	6.06	500	M71-R4300	BMP71
◎	M71C-500-499	White	12.70	-	9.10	-	-	1	M71-R4300	BMP71
▲	M71-7-499	White	12.70	12.70	-	15.88	3.03	500	M71-R4300	BMP71
▲	BM71-11-499	White	12.70	19.05	-	15.88	4.55	5000	R4300	M611, BMP61, BMP71
▲	M71-11-499	White	12.70	19.05	-	15.88	4.55	500	M71-R4300	BMP71
▲	M71-29-499	White	12.70	38.10	-	15.88	9.10	500	M71-R4300	BMP71
▲	M71-67-499-YL	Yellow	15.00	9.00	-	-	-	750	M71-R4300	BMP71
▲	M71-41-499-YL	Yellow	16.00	5.00	-	-	-	750	M71-R4300	BMP71
▲	M71-18-499	White	19.05	25.40	-	22.23	6.06	250	M71-R4300	BMP71
▲	M71-30-499	White	19.05	38.10	-	22.23	9.10	250	M71-R4300	BMP71
▲	M71-84-499	White	22.86	12.70	-	15.88	6.06	500	M71-R4300	BMP71
◎	M71C-1000-499	White	25.40	-	9.10	-	-	1	M71-R4300	BMP71
▲	M71-19-499	White	25.40	25.40	-	28.58	6.06	250	M71-R4300	BMP71
▲	M71-31-499	White	25.40	38.10	-	28.58	9.10	250	M71-R4300	BMP71
▲	M71-21-499	White	25.40	63.50	-	66.68	15.60	100	M71-R4300	BMP71
▲	M71-28-499	White	38.10	6.35	-	9.53	9.10	750	M71-R4300	BMP71
◎	M71C-1900-499	White	48.26	-	9.10	-	-	1	M71-R4300	BMP71
▲	M71-78-499	White	48.26	25.40	-	28.58	10.00	250	M71-R4300	BMP71
▲	M71-81-499	White	48.26	6.35	-	9.53	10.00	750	M71-R4300	BMP71

Order references beginning with "B" indicate bulk rolls.



Fibre optic labels/flags

These fibre optic flags allow more legible information to be printed on smaller diameter wires and permit you to handle and view labels without touching the wires.

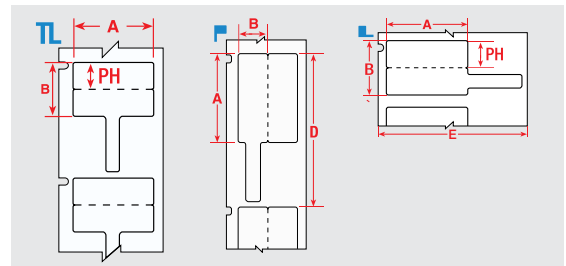

Diagram	Order Reference	Colour	Label Width A (mm)	Label Height B (mm)	Printable Area Height PH (mm)	Vertical Repeat D (mm)	Labels per Roll	Printer Ribbon Series	Printer Compatibility
B-425A: Polypropylene									
└	M71FP-1-425	White	30.00	20.00	10.00	23.50	250	M71-R4300	BMP71
TL	M71FT-1-425	White	30.00	20.00	10.00	43.56	250	M71-R4300	BMP71
┐	M71FP-2-425	White	44.45	25.40	25.40	66.68	100	M71-R4300	BMP71

Electrical, voice/datacom identification

Wire & cable marking



RAPIDO plastic wiremarkers

- Yellow coated polyethylene tag suitable for durable wire marking for electrical devices and fibre installations.

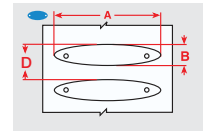

Diagram	Order Reference	Colour	Label Width A (mm)	Label Height B (mm)	Max. Lines of Text	Max. Characters per Line	Vertical Repeat D (mm)	Min. Wire Diameter (mm)	Max. Wire Diameter (mm)	Labels per Roll	Printer Ribbon Series	Printer Compatibility
B-7599: Polyethylene												
	BM71R-1-7599-YL	Yellow	22.90	5.20	1	11	8.38	0.25	1.50	2500	R6200	M611, BMP61, BMP71
	BM71R-2-7599-YL	Yellow	23.00	5.20	1	8	8.38	0.75	2.60	2500	R6200	M611, BMP61, BMP71
	BM71R-3-7599-YL	Yellow	25.00	5.70	2	7	8.89	1.25	3.30	2500	R6200	M611, BMP61, BMP71
	BM71R-4-7599-YL	Yellow	26.00	7.00	2	7	10.82	1.75	4.60	2500	R6200	M611, BMP61, BMP71
	BM71R-5-7599-YL	Yellow	41.00	11.00	3	17	14.20	2.25	7.50	2500	R6200	M611, BMP61, BMP71

Order references beginning with "B" indicate bulk rolls.



Tear resistant cable markers

- These extremely tear resistant cable markers can be used for a variety of applications including identification of multiconductor cables, inventory and equipment.

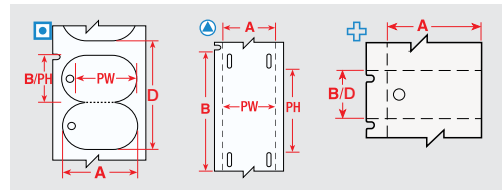

Diagram	Order Reference	Colour	Label Width A (mm)	Label Height B (mm)	Printable Area Width PW (mm)	Printable Area Height PH (mm)	Vertical Repeat D (mm)	Labels per Roll	Printer Ribbon Series	Printer Compatibility
B-109: Polyethylene										
	M71-60-109	White	12.00	50.00	12.00	33.00	50.17	100	M71-R4300	BMP71
	BM71-60-109	White	12.00	50.00	12.00	33.00	50.17	1000	R4300	M611, BMP61, BMP71
	M71-12-109	White	19.05	76.20	17.78	52.07	76.20	100	M71-R4300	BMP71
	BM71-12-109	White	19.05	76.20	17.78	52.07	76.20	1000	R4300	M611, BMP61, BMP71
	M71-36-109	White	44.45	28.58	44.45	28.58	28.58	250	M71-R4300	BMP71
B-145: Polyethylene										
	BM71-111-145-GY	Grey	19.25	30.63	20.62	19.25	58.72	1000	M71-R6000HF	BMP71
	M71-111-145-GY	Grey	30.63	19.25	20.62	19.25	58.72	100	M71-R6000HF	BMP71
	M71-111-145-FR-GY	Grey	30.63	19.25	20.62	19.25	58.72	100	M71-R6000HF	BMP71
	M71-110-145-GY	Grey	44.45	25.40	38.10	25.40	69.85	100	M71-R6000HF	BMP71
	BM71-110-145-GY	Grey	44.45	25.40	38.10	25.40	69.85	1000	M71-R6000HF	BMP71

Order references beginning with "B" indicate bulk rolls.

Coloured Nylon Ties

- Perfect for colour coded applications.

Order Reference	Colour	Width (mm)	Length (mm)	Quantity
196283	Black	3.50	200.00	100
196311	White	3.50	200.00	100
196352	Yellow	3.50	200.00	100
196349	Blue	3.60	200.00	100
196350	Green	3.60	200.00	100
196351	Red	3.60	200.00	100



Wire & cable marking



B-7598 Polyester cable tag

The B-7598 polyester tag is a general identification tag for cables exposed to extreme conditions. It requires cable ties to apply to cables with various diameters. Common applications for this cable tag material are:

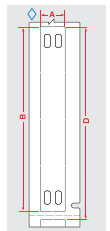

- Identification of multi-conductor cables
- Identification of cables in mobile phone towers
- Identification of datacom or telecom cables in general
- General cable identification that must be extremely resistant

Diagram	Order Reference	Material	Colour	Label Width A (mm)	Label Height B (mm)	Vertical Repeat D (mm)	Labels per Row	Labels per Package	Ribbon Series	Printer Compatibility
◇	BM71-10X60-7598-WT	Polyester	White	10.00	60.00	65.09	1	500	R6000	M611, BMP61, BMP71
◇	BM71-10X60-7598-YL	Polyester	Yellow	10.00	60.00	65.09	1	500	R6000	M611, BMP61, BMP71
◇	BM71-10X60-7598-GN	Polyester	Green	10.00	60.00	65.09	1	500	R6000	M611, BMP61, BMP71
◇	BM71-10X60-7598-RD	Polyester	Red	10.00	60.00	65.09	1	500	R6000	M611, BMP61, BMP71
◇	BM71-10X60-7598-SV	Polyester	Silver	10.00	60.00	65.09	1	500	R6000	M611, BMP61, BMP71
◇	BM71-10X60-7598-BK	Polyester	Black	10.00	60.00	65.09	1	500	R4400-WT	M611, BMP61, BMP71
◇	BM71-10X60-7598-BL	Polyester	Blue	10.00	60.00	65.09	1	500	R6000	M611, BMP61, BMP71
◇	BM71-10X75-7598-WT	Polyester	White	10.00	75.00	80.43	1	250	R6000	M611, BMP61, BMP71
◇	BM71-10X75-7598-YL	Polyester	Yellow	10.00	75.00	80.43	1	250	R6000	M611, BMP61, BMP71
◇	BM71-10X75-7598-GN	Polyester	Green	10.00	75.00	80.43	1	250	R6000	M611, BMP61, BMP71
◇	BM71-10X75-7598-RD	Polyester	Red	10.00	75.00	80.43	1	250	R6000	M611, BMP61, BMP71
◇	BM71-10X75-7598-SV	Polyester	Silver	10.00	75.00	80.43	1	250	R6000	M611, BMP61, BMP71
◇	BM71-10X75-7598-BK	Polyester	Black	10.00	75.00	80.43	1	250	R4400-WT	M611, BMP61, BMP71
◇	BM71-10X75-7598-BL	Polyester	Blue	10.00	75.00	80.43	1	250	R6000	M611, BMP61, BMP71
◇	BM71-15X75-7598-WT	Polyester	White	15.00	75.00	80.43	1	250	R6000	M611, BMP61, BMP71
◇	BM71-15X75-7598-YL	Polyester	Yellow	15.00	75.00	80.43	1	250	R6000	M611, BMP61, BMP71
◇	BM71-15X75-7598-GN	Polyester	Green	15.00	75.00	80.43	1	250	R6000	M611, BMP61, BMP71
◇	BM71-15X75-7598-RD	Polyester	Red	15.00	75.00	80.43	1	250	R6000	M611, BMP61, BMP71
◇	BM71-15X75-7598-SV	Polyester	Silver	15.00	75.00	80.43	1	250	R6000	M611, BMP61, BMP71
◇	BM71-15X75-7598-BK	Polyester	Black	15.00	75.00	80.43	1	250	R4400-WT	M611, BMP61, BMP71
◇	BM71-15X75-7598-BL	Polyester	Blue	15.00	75.00	80.43	1	250	R6000	M611, BMP61, BMP71
◇	BM71-25X75-7598-WT	Polyester	White	25.00	75.00	80.43	1	250	R6000	M611, BMP61, BMP71
◇	BM71-25X75-7598-YL	Polyester	Yellow	25.00	75.00	80.43	1	250	R6000	M611, BMP61, BMP71
◇	BM71-25X75-7598-GN	Polyester	Green	25.00	75.00	80.43	1	250	R6000	M611, BMP61, BMP71
◇	BM71-25X75-7598-RD	Polyester	Red	25.00	75.00	80.43	1	250	R6000	M611, BMP61, BMP71
◇	BM71-25X75-7598-SV	Polyester	Silver	25.00	75.00	80.43	1	250	R6000	M611, BMP61, BMP71
◇	BM71-25X75-7598-BK	Polyester	Black	25.00	75.00	80.43	1	250	R4400-WT	M611, BMP61, BMP71
◇	BM71-25X75-7598-BL	Polyester	Blue	25.00	75.00	80.43	1	250	R6000	M611, BMP61, BMP71

Order references beginning with "B" indicate bulk rolls.

▶ See pages 49 - 51 for a detailed material index.

Wire & cable marking

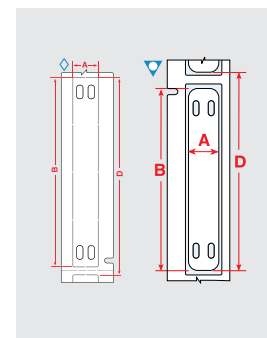
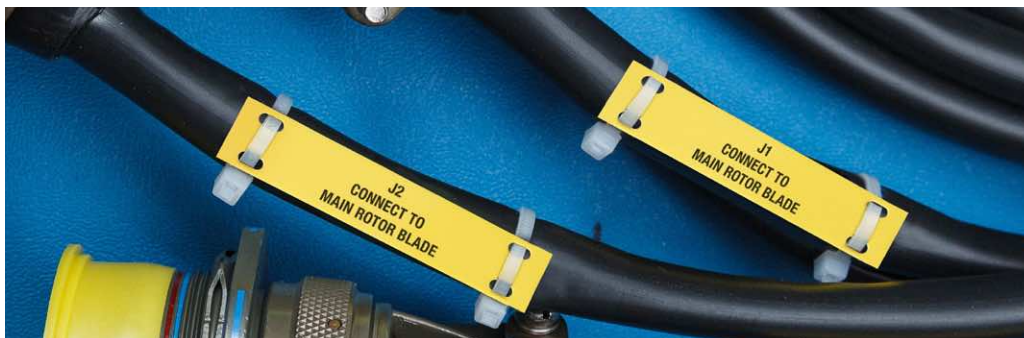

B-7643 Halogen-free cable tag

- These cable markers are made of halogen-free polyurethane material.
- The markers are tough, imperishable and with a very high degree of mark permanence in almost any environment.

Diagram	Order Reference	Colour	Label Width A (mm)	Label Height B (mm)	Vertical Repeat D (mm)	Labels per Roll	Printer Ribbon Series	Printer Compatibility
B-7643: Thermoplastic Polyether Polyurethane								
◇	BM71-10X60-7643-BK	Black	10.00	60.00	65.09	250	R4400	BMP71
◇	BM71-10X60-7643-BL	Blue	10.00	60.00	65.09	250	R6000	BMP71
◇	BM71-10X60-7643-GN	Green	10.00	60.00	65.09	250	R6000	BMP71
◇	BM71-10X60-7643-OR	Orange	10.00	60.00	65.09	250	R6000	BMP71
◇	BM71-10X60-7643-RD	Red	10.00	60.00	65.09	250	R6000	BMP71
◇	BM71-10X60-7643-WT	White	10.00	60.00	65.09	250	R6000	BMP71
◇	BM71-10X60-7643-YL	Yellow	10.00	60.00	65.09	250	R6000	BMP71
◇	BM71-10X75-7643-BK	Black	10.00	75.00	80.43	250	R4400-WT	BMP71
◇	BM71-10X75-7643-BL	Blue	10.00	75.00	80.43	250	R6000	BMP71
◇	BM71-10X75-7643-GN	Green	10.00	75.00	80.43	250	R6000	BMP71
◇	BM71-10X75-7643-OR	Orange	10.00	75.00	80.43	250	R6000	BMP71
◇	BM71-10X75-7643-RD	Red	10.00	75.00	80.43	250	R6000	BMP71
◇	BM71-10X75-7643-WT	White	10.00	75.00	80.43	250	R6000	BMP71
◇	BM71-10X75-7643-YL	Yellow	10.00	75.00	80.43	250	R6000	BMP71
◇	BM71-15X75-7643-BK	Black	15.00	75.00	80.43	250	R4400-WT	M611, BMP61, BMP71
◇	BM71-15X75-7643-BL	Blue	15.00	75.00	80.43	250	R6000	M611, BMP61, BMP71
◇	BM71-15X75-7643-GN	Green	15.00	75.00	80.43	250	R6000	M611, BMP61, BMP71
◇	BM71-15X75-7643-OR	Orange	15.00	75.00	80.43	250	R6000	M611, BMP61, BMP71
◇	BM71-15X75-7643-RD	Red	15.00	75.00	80.43	250	R6000	M611, BMP61, BMP71
◇	BM71-15X75-7643-WT	White	15.00	75.00	80.43	250	R6000	M611, BMP61, BMP71
◇	BM71-15X75-7643-YL	Yellow	15.00	75.00	80.43	250	R6000	M611, BMP61, BMP71
◇	BM71-25X75-7643-BK	Black	25.00	75.00	80.43	250	R4410-WT	M611, BMP61, BMP71
◇	BM71-25X75-7643-BL	Blue	25.00	75.00	80.43	250	R6000	M611, BMP61, BMP71
◇	BM71-25X75-7643-GN	Green	25.00	75.00	80.43	250	R6000	M611, BMP61, BMP71
◇	BM71-25X75-7643-OR	Orange	25.00	75.00	80.43	250	R6000	M611, BMP61, BMP71
◇	BM71-25X75-7643-RD	Red	25.00	75.00	80.43	250	R6000	M611, BMP61, BMP71
◇	BM71-25X75-7643-WT	White	25.00	75.00	80.43	250	R6000	M611, BMP61, BMP71
◇	BM71-25X75-7643-YL	Yellow	25.00	75.00	80.43	250	R6000	M611, BMP61, BMP71
▽	BM71H-1-7643-WT	White	10.00	60.00	65.88	250	M71-R6000HF	M611, BMP61, BMP71
▽	BM71H-1-7643-YL	Yellow	10.00	60.00	65.88	250	M71-R6000HF	M611, BMP61, BMP71
▽	BM71H-2-7643-WT	White	10.00	75.00	81.17	250	M71-R6000HF	M611, BMP61, BMP71
▽	BM71H-2-7643-YL	Yellow	10.00	75.00	81.17	250	M71-R6000HF	M611, BMP61, BMP71
▽	BM71H-3-7643-WT	White	25.00	75.00	82.55	250	M71-R6000HF	M611, BMP61, BMP71
▽	BM71H-3-7643-YL	Yellow	25.00	75.00	82.55	250	M71-R6000HF	M611, BMP61, BMP71

Order references beginning with "B" indicate bulk rolls.

Wire & cable marking

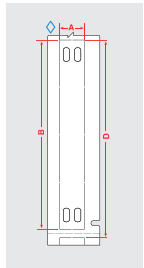

B-348 Mass transit tag

- The B-348 Mass Transit Tag complies with minimal smoke and halogen emission requirements of the most strict underground norms for mass transit vehicles.
- Printable both on-site and in the field, the tag is a practical solution for mass transit manufacturers to identify thick cables and cable bundles.

Diagram	Order Reference	Colour	Label Width A (mm)	Label Height B (mm)	Vertical Repeat D (mm)	Labels per Roll	Printer Ribbon Series	Printer Compatibility
B-348: Polyolefin								
◇	BM61-10X60-348-WT	White	10.00	60.00	65.09	250	M71-R6000HF	M611, BMP61, BMP71
◇	BM61-10X60-348-YL	Yellow	10.00	60.00	65.09	250	M71-R6000HF	M611, BMP61, BMP71
◇	BM61-10X75-348-WT	White	10.00	75.00	80.43	250	M71-R6000HF	M611, BMP61, BMP71
◇	BM61-10X75-348-YL	Yellow	10.00	75.00	80.43	250	M71-R6000HF	M611, BMP61, BMP71
◇	BM61-15X75-348-WT	White	15.00	75.00	80.43	250	M71-R6000HF	M611, BMP61, BMP71
◇	BM61-15X75-348-YL	Yellow	15.00	75.00	80.43	250	M71-R6000HF	M611, BMP61, BMP71
◇	BM61-25X75-348-WT	White	25.00	75.00	80.43	250	M71-R6000HF	M611, BMP61, BMP71
◇	BM61-25X75-348-YL	Yellow	25.00	75.00	80.43	250	M71-R6000HF	M611, BMP61, BMP71



BradyGrip™ print-on hook material

BradyGrip™ Print-on Hook Material is a one-of-a-kind solution that allows identification to be easily printed and placed on bundles. A grippy backing makes it easy to reposition or remove, so no need for costly rework. Just print on and place - it's that simple.

- Maximises your uptime with faster, printable ID for cable bundles.
- Apply, reposition and remove with exclusive, print-and-place material.
- Offers a non-damaging alternative to nylon cable ties.
- Customise labels to fit big or small jobs by printing on different-width material.

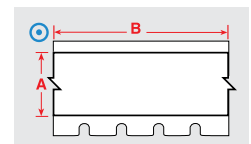

Diagram	Order Reference	Colour	Label Width A (mm)	Label Length B (m)	Printer Compatibility
B-414: Polyester					
⊙	M71C-250-414	White	6.35	6.10 m	BMP71
⊙	M71C-500-414	White	12.70	6.10 m	BMP71
⊙	M71C-750-414	White	19.05	6.10 m	BMP71
⊙	M71C-1000-414	White	25.40	6.10 m	BMP71
⊙	M71C-1500-414	White	38.10	6.10 m	BMP71

▶ See pages 49 - 51 for a detailed material index.

Wire & cable marking



DuraSleeve inserts

- Brady DuraSleeve printable inserts create a durable legend.
- Tags and inserts easily slide into the clear carriers.
- The legend can be changed before or after termination.

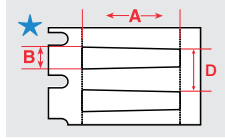

Diagram	Order Reference	Colour	Label Width A (mm)	Label Height B (mm)	Vertical Repeat D (mm)	Labels per Roll	Printer Ribbon Series	Printer Compatibility
B-7696: Vinyl								
★	BM71D-1-7696	White	10.00	4.40	7.56	2500	R6000HF	M611, BMP61, BMP71
★	BM71D-1-7696-YL	Yellow	10.00	4.40	7.56	2500	R6000HF	M611, BMP61, BMP71
★	M71D-1-7696	White	10.00	4.40	7.56	500	M71-R6000HF	BMP71
★	M71D-1-7696-YL	Yellow	10.00	4.40	7.56	500	M71-R6000HF	BMP71
★	BM71D-2-7696	White	12.00	4.40	7.56	2500	R6000HF	M611, BMP61, BMP71
★	BM71D-2-7696-YL	Yellow	12.00	4.40	7.56	2500	R6000HF	M611, BMP61, BMP71
★	M71D-2-7696	White	12.00	4.40	7.56	500	M71-R6000HF	BMP71
★	M71D-2-7696-YL	Yellow	12.00	4.40	7.56	500	M71-R6000HF	BMP71
★	BM71D-3-7696	White	16.00	4.40	7.56	2500	R6000HF	M611, BMP61, BMP71
★	BM71D-3-7696-YL	Yellow	16.00	4.40	7.56	5000	R6000HF	M611, BMP61, BMP71
★	M71D-3-7696	White	16.00	4.40	7.56	500	M71-R6000HF	BMP71
★	BM71D-4-7696	White	23.00	4.40	7.56	2500	R6000HF	M611, BMP61, BMP71
★	BM71D-4-7696-YL	Yellow	23.00	4.40	7.56	2500	R6000HF	M611, BMP61, BMP71
★	M71D-4-7696	White	23.00	4.40	7.56	500	M71-R6000HF	BMP71
★	M71D-4-7696-YL	Yellow	23.00	4.40	7.56	500	M71-R6000HF	BMP71
★	BM71D-5-7696	White	30.00	4.40	7.56	2500	R6000HF	M611, BMP61, BMP71
★	BM71D-5-7696-YL	Yellow	30.00	4.40	7.56	5000	R6000HF	M611, BMP61, BMP71
★	M71D-5-7696	White	30.00	4.40	7.56	500	M71-R6000HF	BMP71
B-7697: Polyester								
★	M71D-1-7697-WT	White	10.00	4.40	7.58	500	M71-R4300, M71-R6200	BMP71
★	M71D-2-7697-WT	White	12.00	4.40	7.58	500	M71-R4300, M71-R6200	BMP71
★	M71D-3-7697-WT	White	16.00	4.40	7.58	500	M71-R4300, M71-R6200	BMP71
★	M71D-4-7697-WT	White	23.00	4.40	7.58	500	M71-R4300, M71-R6200	BMP71
★	M71D-5-7697-WT	White	30.00	4.40	7.58	500	M71-R4300, M71-R6200	BMP71

Order references beginning with "B" indicate bulk rolls.

DuraSleeve tag carrier

DuraSleeve tag carriers are produced in transparent PVC. The special shape of the carrier allows it to adapt to cables of various diameters. There are several sizes of carriers which cater for cables with external diameters from 1.30 mm up to 15 mm.

- Temperature range: -40 °C to 60 °C
- Material: PVC

Please contact your local Brady representative to identify and select the most appropriate carrier for your individual application.



Component & equipment marking

EPREP: Engraved Plate REplacement Labels

Brady EPREP labels are innovative labels specifically designed to replace engraved and plotted plates for identification of electrical components, electrical cabinets, push buttons, patch panels etc.

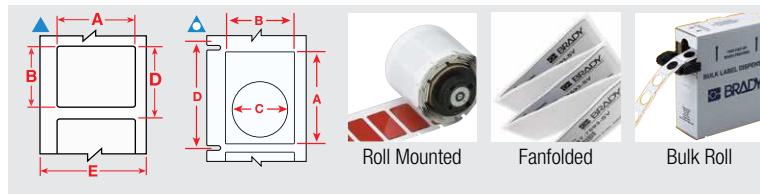

Diagram	Order Reference	Colour	Label Width A (mm)	Label Height B (mm)	Hole Diameter C (mm)	Vertical Repeat D (mm)	Labels per Roll	Layout	Printer Ribbon Series	Printer Compatibility
B-7593: Polyethylene Foam Laminate Polyester										
▲	M71EP-1-7593-SL	Silver	27.00	8.00	-	11.18	250	Roll Mounted	M71-R6000HF	BMP71
▲	M71EP-1-7593-WT	White	27.00	8.00	-	11.18	250	Roll Mounted	M71-R6000HF	BMP71
▲	M71EP-2-7593-SL	Silver	27.00	12.50	-	15.63	250	Roll Mounted	M71-R6000HF	BMP71
▲	M71EP-2-7593-WT	White	27.00	12.50	-	15.63	250	Roll Mounted	M71-R6000HF	BMP71
▲	M71EP-3-7593-SL	Silver	27.00	15.00	-	18.14	150	Roll Mounted	M71-R6000HF	BMP71
▲	M71EP-3-7593-WT	White	27.00	15.00	-	18.14	150	Roll Mounted	M71-R6000HF	BMP71
▲	M71EP-4-7593-SL	Silver	27.00	18.00	-	21.25	150	Roll Mounted	M71-R6000HF	BMP71
▲	M71EP-4-7593-WT	White	27.00	18.00	-	21.25	150	Roll Mounted	M71-R6000HF	BMP71
△	M71EP-5-7593-BK	Black	30.00	40.00	24.00	50.80	100	Fan-folded	M71-R4400-WT	BMP71
△	M71EP-5-7593-GN	Green	30.00	40.00	24.00	50.80	100	Fan-folded	M71-R6000HF	BMP71
△	M71EP-5-7593-RD	Red	30.00	40.00	24.00	50.80	100	Fan-folded	M71-R6000HF	BMP71
△	M71EP-5-7593-SL	Silver	30.00	40.00	24.00	50.80	100	Fan-folded	M71-R6000HF	BMP71
△	M71EP-5-7593-WT	White	30.00	40.00	24.00	50.80	100	Fan-folded	M71-R6000HF	BMP71
△	M71EP-5-7593-YL	Yellow	30.00	40.00	24.00	50.80	100	Fan-folded	M71-R6000HF	BMP71
▲	M71EP-7-7593-SL	Silver	35.00	18.00	-	21.49	100	Roll Mounted	M71-R6000HF	BMP71
▲	M71EP-7-7593-WT	White	35.00	18.00	-	21.49	100	Roll Mounted	M71-R6000HF	BMP71
▲	M71EP-7-7593-YL	Yellow	35.00	18.00	-	21.49	100	Roll Mounted	M71-R6000HF	BMP71
▲	M71EP-6-7593-BK	Black	45.00	15.00	-	40.37	100	Fan-folded	M71-R4400-WT	BMP71
▲	M71EP-6-7593-RD	Red	45.00	15.00	-	40.37	100	Fan-folded	M71-R6000HF	BMP71
▲	BM71E-6-7593-SL	Silver	45.00	15.00	-	18.26	500	Bulk Roll	M71-R6000HF	BMP71
▲	BM71E-6-7593-WT	White	45.00	15.00	-	18.26	500	Bulk Roll	M71-R6000HF	BMP71
▲	M71EP-6-7593-YL	Yellow	45.00	15.00	-	40.37	100	Fan-folded	M71-R6000HF	BMP71
▲	M71EP-8-7593-SL	Silver	48.00	19.00	-	22.46	125	Roll Mounted	M71-R6000HF	BMP71
▲	M71EP-8-7593-WT	White	48.00	19.00	-	22.46	125	Roll Mounted	M71-R6000HF	BMP71

Order references beginning with "B" indicate bulk rolls.

Terminal block markers

Repositionable vinyl cloth marker with a firm adhesive offering excellent holding power, but can be easily removed and reapplied.

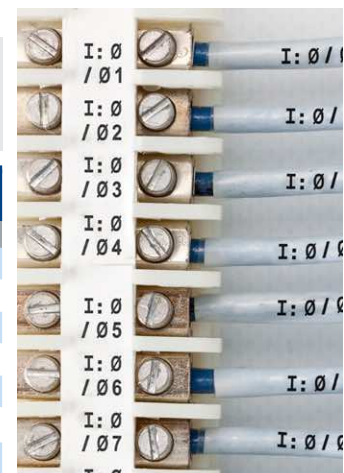
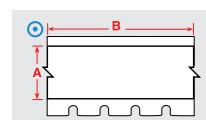
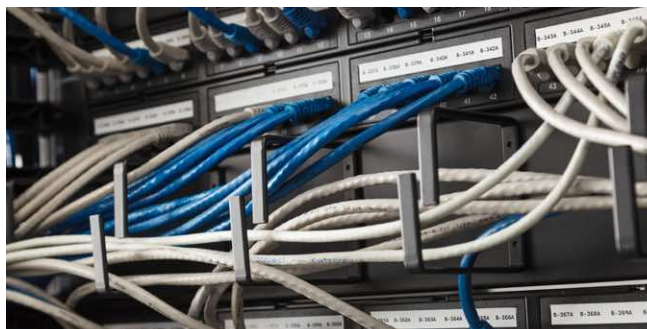

Diagram	Order Reference	Colour	Label Width A (mm)	Label Length B (mm)	Labels per Roll	Printer Ribbon Series	Printer Compatibility
B-498: Vinyl Cloth							
⊙	M71C-500-498	White	12.70	9.10	1	M71-R6200	BMP71
⊙	M71C-240-498	White	6.10	9.14	1	M71-R6200	BMP71
⊙	M71C-318-498	White	8.08	9.14	1	M71-R6200	BMP71
⊙	M71C-375-498	White	9.53	9.14	1	M71-R6200	BMP71
⊙	BM71C-240-498	White	6.10	83.80	1	R6200	M611, BMP61, BMP71
⊙	BM71C-318-498	White	8.08	83.80	1	R6200	M611, BMP61, BMP71
⊙	BM71C-375-498	White	9.53	83.80	1	R6200	M611, BMP61, BMP71

Order references beginning with "B" indicate bulk rolls.

▶ See pages 49 - 51 for a detailed material index.

Component & equipment marking



Punch block and patch panel labels

- Create a fully-formatted serialised punch block label to fit your equipment.
- Label your ports, jack and outlets with adhesive labels or slide-in strips.

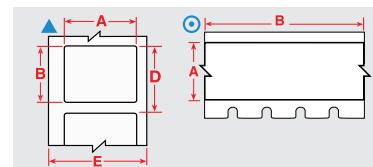

Diagram	Order Reference	Colour	Label Width A (mm)	Label Height B (mm)	Label Length B (m)	Vertical Repeat D (mm)	Labels per Roll	Printer Ribbon Series	Printer Compatibility
B-412: Polypropylene									
⊙	M71C-230-412	White	5.84	-	15.24	-	1	M71-R6200	BMP71
⊙	M71C-375-412	White	9.53	-	15.24	-	1	M71-R6200	BMP71
⊙	M71C-475-412	White	12.07	-	15.24	-	1	M71-R6200	BMP71
⊙	M71C-500-412	White	12.70	-	15.24	-	1	M71-R6200	BMP71
⊙	M71C-625-412	White	15.88	-	15.24	-	1	M71-R6200	BMP71
⊙	M71C-785-412	White	19.94	-	15.24	-	1	M71-R6200	BMP71
B-422: Polyester									
▲	M71-30-422	White	38.10	19.05	-	22.23	250	M71-R6000HF	BMP71
▲	M71-45-422	White	38.10	9.53	-	12.70	500	M71-R6000HF	BMP71
⊙	M71C-375-422	White	9.53	-	15.24	-	1	M71-R6000HF	BMP71
⊙	M71C-475-422	White	12.07	-	15.24	-	1	M71-R6000HF	BMP71
⊙	M71C-500-422	White	12.70	-	15.24	-	1	M71-R6000HF	BMP71
⊙	M71C-625-422	White	15.88	-	15.24	-	1	M71-R6000HF	BMP71
⊙	M71C-1000-422	White	25.40	-	15.24	-	1	M71-R6000HF	BMP71
B-423: Polyester									
▲	M71-1-423	White	6.35	6.35	-	9.53	750	M71-R6000HF	BMP71
▲	M71-3-423	White	9.53	9.53	-	12.70	500	M71-R6000HF	BMP71
▲	M71-4-423	White	10.16	10.16	-	13.34	500	M71-R6000HF	BMP71
▲	M71-5-423	White	12.70	5.08	-	8.26	750	M71-R6000HF	BMP71
▲	M71-6-423	White	12.70	6.99	-	10.16	750	M71-R6000HF	BMP71
▲	M71-7-423	White	12.70	12.70	-	15.88	500	M71-R6000HF	BMP71
▲	BM71-7-423	White	12.70	12.70	-	15.88	5000	R6000HF	MG11, BMP61, BMP71
▲	M71-9-423	White	16.51	5.08	-	8.26	750	M71-R6000HF	BMP71
▲	M71-10-423	White	19.05	6.35	-	9.53	750	M71-R6000HF	BMP71
▲	M71-13-423	White	22.86	6.35	-	9.53	750	M71-R6000HF	BMP71
▲	M71-14-423	White	25.40	4.75	-	8.26	750	M71-R6000HF	BMP71
▲	M71-15-423	White	25.40	6.99	-	10.16	750	M71-R6000HF	BMP71
▲	BM71-17-423	White	25.40	12.70	-	15.88	5000	R6000HF	MG11, BMP61, BMP71
▲	BM71-16-423	White	25.40	9.53	-	12.70	5000	R6000HF	MG11, BMP61, BMP71
▲	BM71-19-423	White	25.40	25.40	-	28.58	2500	R6000HF	MG11, BMP61, BMP71
▲	M71-16-423	White	25.40	9.53	-	12.70	500	M71-R6000HF	BMP71
▲	M71-17-423	White	25.40	12.70	-	15.88	500	M71-R6000HF	BMP71
▲	M71-19-423	White	25.40	25.40	-	28.58	250	M71-R6000HF	BMP71
▲	M71-25-423	White	31.75	6.35	-	9.53	750	M71-R6000HF	BMP71
▲	M71-27-423	White	38.10	3.18	-	6.35	750	M71-R6000HF	BMP71
▲	M71-28-423	White	38.10	6.35	-	9.53	750	M71-R6000HF	BMP71
▲	M71-29-423	White	38.10	12.70	-	15.88	500	M71-R6000HF	BMP71
▲	M71-32-423	White	38.10	38.10	-	41.28	250	M71-R6000HF	BMP71
▲	BM71-29-423	White	38.10	12.70	-	15.88	5000	R6000HF	MG11, BMP61, BMP71
▲	M71-31-423	White	38.10	25.40	-	28.58	250	M71-R6000HF	BMP71
⊙	M71C-500-423	White	12.70	-	15.24	-	1	M71-R6000HF	BMP71

Order references beginning with "B" indicate bulk rolls.

>>

▶ See pages 49 - 51 for a detailed material index.

Component & equipment marking

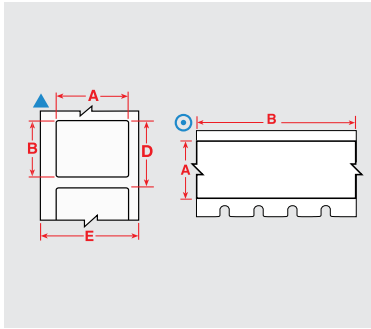

Punch block and patch panel labels (continued)

Diagram	Order Reference	Colour	Label Width A (mm)	Label Height B (mm)	Label Length B (m)	Vertical Repeat D (mm)	Labels per Roll	Printer Ribbon Series	Printer Compatibility
B-428: Metallised Polyester									
▲	M71-15-428	Light Grey	25.40	6.99	-	10.16	750	M71-R4300	BMP71
▲	M71-17-428	Light Grey	25.40	12.70	-	15.88	500	M71-R4300	BMP71
▲	BM71-17-428	Light Grey	25.40	12.70	-	15.88	5000	R4300	M611, BMP61, BMP71
▲	M71-29-428	Light Grey	38.10	12.70	-	15.88	500	M71-R4300	BMP71
⊙	M71C-500-428	Light Grey	12.70	-	15.24	-	1	M71-R4300	BMP71
B-430: Polyester									
▲	M71-68-430	Transparent	6.10	3.18	-	9.53	750	M71-R6000HF	BMP71
▲	M71-71-430	Transparent	8.89	5.08	-	9.53	750	M71-R6000HF	BMP71
▲	M71-16-430	Transparent	25.40	9.53	-	12.70	500	M71-R6000HF	BMP71
▲	M71-17-430	Transparent	25.40	12.70	-	15.88	500	M71-R6000HF	BMP71
▲	M71-45-430	Transparent	38.10	9.53	-	12.70	500	M71-R6000HF	BMP71
⊙	M71C-375-430	Transparent	9.53	-	15.24	-	1	M71-R6000HF	BMP71
⊙	M71C-500-430	Transparent	12.70	-	15.24	-	1	M71-R6000HF	BMP71
⊙	M71C-1000-430	Transparent	25.40	-	15.24	-	1	M71-R6000HF	BMP71
B-483A: Polyester									
▲	M71-16-483	White	25.40	9.53	-	12.70	500	M71-R6000HF	BMP71
▲	M71-19-483	White	25.40	25.40	-	28.58	250	M71-R6000HF	BMP71
▲	M71-17-483	White	25.40	12.70	-	15.88	500	M71-R6000HF	BMP71
▲	M71-65-483	White	34.93	25.40	-	28.58	250	M71-R6000HF	BMP71
▲	M71-29-483	White	38.10	12.70	-	15.88	500	M71-R6000HF	BMP71
▲	M71-30-483	White	38.10	19.05	-	22.23	250	M71-R6000HF	BMP71
▲	M71-31-483	White	38.10	25.40	-	28.58	250	M71-R6000HF	BMP71
⊙	M71C-500-483	White	12.70	-	15.24	-	1	M71-R6000HF	BMP71
⊙	M71C-1000-483	White	25.40	-	15.24	-	1	M71-R6000HF	BMP71

Order references beginning with "B" indicate bulk rolls.

Workstation labels

A variety of durable and resistant materials to label your workstation.

Diagram	Order Reference	Colour	Label Width A (mm)	Label Height B (mm)	Vertical Repeat D (mm)	Labels per Roll	For Data Cables Sized to Fit	Printer Ribbon Series
B-412: Polypropylene								
⊗	M71-40-412	White	49.23	9.53	9.53	750	Desi-Strip Inserts	M71-R6200
⊗	BM71-40-412	White	49.23	9.53	9.53	5000	Desi-Strip Inserts	R6200
B-422: Polyester								
▲	M71-45-422	White	38.10	9.53	12.70	500	Location Identification	M71-R6000HF
B-430: Polyester								
▲	M71-68-430	Transparent	6.10	3.18	9.53	750	Siemens Faceplates	M71-R6000HF
▲	M71-71-430	Transparent	8.89	5.08	9.53	750	Siemens Faceplates	M71-R6000HF
▲	M71-16-430	Transparent	25.40	9.53	12.70	500	Location Identification; 1-4 Outlet Faceplates	M71-R6000HF
▲	M71-17-430	Transparent	25.40	12.70	15.88	500	Location Identification; 1-4 Outlet Faceplates	M71-R6000HF
▲	M71-45-430	Transparent	38.10	9.53	12.70	500	Location Identification	M71-R6000HF

Order references beginning with "B" indicate bulk rolls.

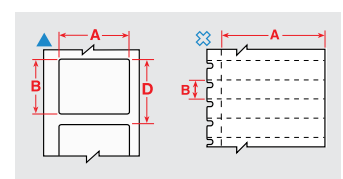

Asset & component marking



Rating and name plate labels

Choose from several materials with aggressive adhesives for use in commercial/industrial applications, including low surface energy and textured surfaces.

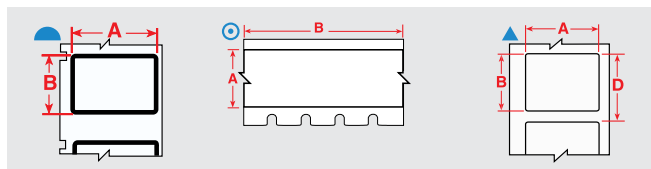

For rough surfaces

Diagram	Order Reference	Colour	Label Width A (mm)	Label Height B (mm)	Label Length B (m)	Vertical Repeat D (mm)	Labels per Roll	Printer Ribbon Series	Printer Compatibility
B-483A: Polyester									
▲	M71-61-483	White	12.70	50.80	-	53.98	100	M71-R6000HF	BMP71
▲	M71-16-483	White	25.40	9.53	-	12.70	500	M71-R6000HF	BMP71
▲	M71-19-483	White	25.40	25.40	-	28.58	250	M71-R6000HF	BMP71
▲	M71-17-483	White	25.40	12.70	-	15.88	500	M71-R6000HF	BMP71
▲	M71-20-483	White	25.40	50.80	-	53.98	100	M71-R6000HF	BMP71
▲	M71-65-483	White	34.93	25.40	-	28.58	250	M71-R6000HF	BMP71
▲	M71-29-483	White	38.10	12.70	-	15.88	500	M71-R6000HF	BMP71
▲	M71-30-483	White	38.10	19.05	-	22.23	250	M71-R6000HF	BMP71
▲	M71-31-483	White	38.10	25.40	-	28.58	250	M71-R6000HF	BMP71
▲	M71-37-483	White	76.20	48.26	-	79.38	100	M71-R6000HF	BMP71
▲	M71-38-483	White	101.60	48.26	-	104.78	100	M71-R6000HF	BMP71
▲	M71-23-483	White	101.60	25.40	-	104.78	100	M71-R6000HF	BMP71
⊙	M71C-500-483	White	12.70	-	15.24	-	1	M71-R6000HF	BMP71
⊙	M71C-1000-483	White	25.40	-	15.24	-	1	M71-R6000HF	BMP71
⊙	M71C-1900-483	White	48.26	-	15.24	-	1	M71-R6000HF	BMP71
B-486B: Metallised Polyester									
▲	M71-17-486	Light Grey	25.40	12.70	-	15.88	500	M71-R4300	BMP71
▲	M71-20-486	Light Grey	25.40	50.80	-	53.98	100	M71-R4300	BMP71
▲	M71-29-486	Light Grey	38.10	12.70	-	15.88	500	M71-R4300	BMP71
▲	M71-30-486	Light Grey	38.10	19.05	-	22.23	250	M71-R4300	BMP71
▲	M71-37-486	Light Grey	76.20	48.26	-	79.38	100	M71-R4300	BMP71
B-489A: Polyester									
▲	M71-17-489	White	25.40	12.70	-	15.88	500	M71-R6200	BMP71
▲	M71-29-489	White	38.10	12.70	-	15.88	500	M71-R6200	BMP71
▲	M71-32-489	White	38.10	38.10	-	41.28	250	M71-R6200	BMP71
▲	M71-38-489	White	101.60	48.26	-	104.78	100	M71-R6200	BMP71

For low energy and textured surfaces

Diagram	Order Reference	Colour	Label Width A (mm)	Label Height B (mm)	Label Length B (m)	Vertical Repeat D (mm)	Labels per Roll	Printer Ribbon Series	Printer Compatibility
B-422: Polyester									
▲	BM71-20-422	White	25.40	50.80	-	53.98	1000	R6000HF	M611, BMP61, BMP71
▲	M71-30-422	White	38.10	19.05	-	22.23	250	M71-R6000HF	BMP71
▲	M71-45-422	White	38.10	9.53	-	12.70	500	M71-R6000HF	BMP71
▲	M71-37-422	White	76.20	48.26	-	79.38	100	M71-R6000HF	BMP71
⊙	M71C-375-422	White	9.53	-	15.24	-	1	M71-R6000HF	BMP71
⊙	M71C-475-422	White	12.07	-	15.24	-	1	M71-R6000HF	BMP71
⊙	M71C-500-422	White	12.70	-	15.24	-	1	M71-R6000HF	BMP71
⊙	M71C-625-422	White	15.88	-	15.24	-	1	M71-R6000HF	BMP71
⊙	M71C-1000-422	White	25.40	-	15.24	-	1	M71-R6000HF	BMP71
⊙	M71C-1900-422	White	48.26	-	15.24	-	1	M71-R6000HF	BMP71

Order references beginning with "B" indicate bulk rolls.

>>

▶ See pages 49 - 51 for a detailed material index.

Asset & component marking

Rating and name plate labels (continued)

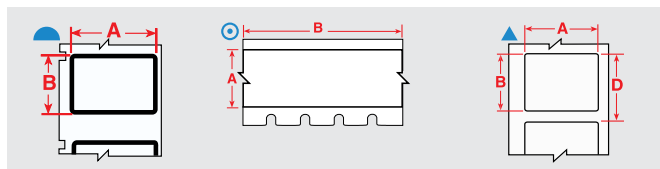

For low energy and textured surfaces (continued)

Diagram	Order Reference	Colour	Label Width A (mm)	Label Height B (mm)	Label Length B (m)	Vertical Repeat D (mm)	Labels per Roll	Printer Ribbon Series	Printer Compatibility
B-499: Nylon Cloth									
▲	M71-16-499	White	9.53	25.40	-	12.70	500	M71-R4300	BMP71
▲	M71-29-499	White	12.70	38.10	-	15.88	500	M71-R4300	BMP71
▲	M71-7-499	White	12.70	12.70	-	15.88	500	M71-R4300	BMP71
▲	BM71-11-499	White	12.70	19.05	-	15.88	5000	R4300	M611, BMP61, BMP71
▲	M71-11-499	White	12.70	19.05	-	15.88	500	M71-R4300	BMP71
▲	M71-67-499-YL	Yellow	15.00	9.00	-	-	750	M71-R4300	BMP71
▲	M71-41-499-YL	Yellow	16.00	5.00	-	-	750	M71-R4300	BMP71
▲	M71-18-499	White	19.05	25.40	-	22.23	250	M71-R4300	BMP71
▲	M71-30-499	White	19.05	38.10	-	22.23	250	M71-R4300	BMP71
▲	M71-84-499	White	22.86	12.70	-	15.88	500	M71-R4300	BMP71
▲	M71-19-499	White	25.40	25.40	-	28.58	250	M71-R4300	BMP71
▲	M71-31-499	White	25.40	38.10	-	28.58	250	M71-R4300	BMP71
▲	M71-21-499	White	25.40	63.50	-	66.68	100	M71-R4300	BMP71
▲	M71-28-499	White	38.10	6.35	-	9.53	750	M71-R4300	BMP71
▲	M71-78-499	White	48.26	25.40	-	28.58	250	M71-R4300	BMP71
▲	M71-81-499	White	48.26	6.35	-	9.53	750	M71-R4300	BMP71
⊙	M71C-500-499	White	12.70	-	9.10	-	1	M71-R4300	BMP71
⊙	M71C-1000-499	White	25.40	-	9.10	-	1	M71-R4300	BMP71
⊙	M71C-1900-499	White	48.26	-	9.10	-	1	M71-R4300	BMP71
B-595: Vinyl									
⊙	M71C-500-595-BK	Black	12.70	-	15.24	-	1	M71-R4400-WT	BMP71
⊙	M71C-500-595-BL	Blue	12.70	-	15.24	-	1	M71-R4400-WT	BMP71
⊙	M71C-500-595-GN	Green	12.70	-	15.24	-	1	M71-R4400-WT	BMP71
⊙	M71C-500-595-OR	Orange	12.70	-	15.24	-	1	M71-R6000HF	BMP71
⊙	M71C-500-595-RD	Red	12.70	-	15.24	-	1	M71-R4400-WT	BMP71
⊙	M71C-500-595-CL	Transparent	12.70	-	15.24	-	1	M71-R6000HF	BMP71
⊙	M71C-500-595-WT	White	12.70	-	15.24	-	1	M71-R6000HF	BMP71
⊙	M71C-500-595-YL	Yellow	12.70	-	15.24	-	1	M71-R6000HF	BMP71
⊙	M71C-1000-595-BK	Black	25.40	-	15.24	-	1	M71-R4400-WT	BMP71
⊙	M71C-1000-595-BL	Blue	25.40	-	15.24	-	1	M71-R4400-WT	BMP71
⊙	M71C-1000-595-GN	Green	25.40	-	15.24	-	1	M71-R4400-WT	BMP71
⊙	M71C-1000-595-OR	Orange	25.40	-	15.24	-	1	M71-R6000HF	BMP71
⊙	M71C-1000-595-RD	Red	25.40	-	15.24	-	1	M71-R4400-WT	BMP71
⊙	M71C-1000-595-CL	Transparent	25.40	-	15.24	-	1	M71-R6000HF	BMP71
⊙	M71C-1000-595-WT	White	25.40	-	15.24	-	1	M71-R6000HF	BMP71
⊙	M71C-1000-595-YL	Yellow	25.40	-	15.24	-	1	M71-R6000HF	BMP71
⊙	M71C-2000-595-BK	Black	50.80	-	15.24	-	1	M71-R4400-WT	BMP71
⊙	M71C-2000-595-BL	Blue	50.80	-	15.24	-	1	M71-R4400-WT	BMP71
⊙	M71C-2000-595-GN	Green	50.80	-	15.24	-	1	M71-R4400-WT	BMP71
⊙	M71C-2000-595-OR	Orange	50.80	-	15.24	-	1	M71-R6000HF	BMP71
⊙	M71C-2000-595-RD	Red	50.80	-	15.24	-	1	M71-R4400-WT	BMP71
⊙	M71C-2000-595-CL	Transparent	50.80	-	15.24	-	1	M71-R6000HF	BMP71
⊙	M71C-2000-595-WT	White	50.80	-	15.24	-	1	M71-R6000HF	BMP71
⊙	M71C-2000-595-YL	Yellow	50.80	-	15.24	-	1	M71-R6000HF	BMP71

Order references beginning with "B" indicate bulk rolls.

Asset & component marking

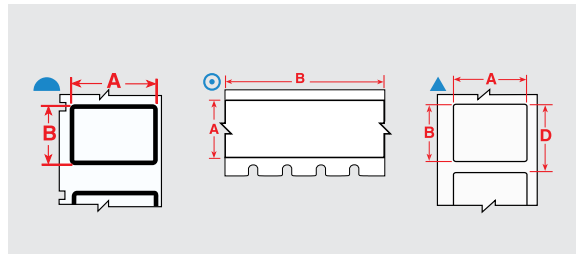

Rating and name plate labels (Continued)

For smooth, high energy surfaces

Diagram	Order Reference	Colour	Label Width A (mm)	Label Height B (mm)	Label Length B (m)	Vertical Repeat D (mm)	Labels per Roll	Printer Ribbon Series	Printer Compatibility
B-423: Polyester									
▲	M71-1-423	White	6.35	6.35	-	9.53	750	M71-R6000HF	BMP71
▲	M71-3-423	White	9.53	9.53	-	12.70	500	M71-R6000HF	BMP71
▲	M71-4-423	White	10.16	10.16	-	13.34	500	M71-R6000HF	BMP71
▲	M71-5-423	White	12.70	5.08	-	8.26	750	M71-R6000HF	BMP71
▲	M71-6-423	White	12.70	6.99	-	10.16	750	M71-R6000HF	BMP71
▲	M71-7-423	White	12.70	12.70	-	15.88	500	M71-R6000HF	BMP71
▲	BM71-7-423	White	12.70	12.70	-	15.88	5000	R6000HF	M611, BMP61, BMP71
▲	M71-9-423	White	16.51	5.08	-	8.26	750	M71-R6000HF	BMP71
▲	M71-10-423	White	19.05	6.35	-	9.53	750	M71-R6000HF	BMP71
▲	M71-13-423	White	22.86	6.35	-	9.53	750	M71-R6000HF	BMP71
▲	M71-14-423	White	25.40	4.75	-	8.26	750	M71-R6000HF	BMP71
▲	M71-15-423	White	25.40	6.99	-	10.16	750	M71-R6000HF	BMP71
▲	M71-20-423	White	25.40	50.80	-	53.98	100	M71-R6000HF	BMP71
▲	BM71-17-423	White	25.40	12.70	-	15.88	5000	R6000HF	M611, BMP61, BMP71
▲	BM71-16-423	White	25.40	9.53	-	12.70	5000	R6000HF	M611, BMP61, BMP71
▲	BM71-19-423	White	25.40	25.40	-	28.58	2500	R6000HF	M611, BMP61, BMP71
▲	M71-16-423	White	25.40	9.53	-	12.70	500	M71-R6000HF	BMP71
▲	M71-17-423	White	25.40	12.70	-	15.88	500	M71-R6000HF	BMP71
▲	M71-19-423	White	25.40	25.40	-	28.58	250	M71-R6000HF	BMP71
▲	M71-24-423-BK	White	28.70	12.70	-	15.88	500	M71-R6000HF	BMP71
▲	M71-25-423	White	31.75	6.35	-	9.53	750	M71-R6000HF	BMP71
▲	M71-27-423	White	38.10	3.18	-	6.35	750	M71-R6000HF	BMP71
▲	M71-28-423	White	38.10	6.35	-	9.53	750	M71-R6000HF	BMP71
▲	M71-29-423	White	38.10	12.70	-	15.88	500	M71-R6000HF	BMP71
▲	M71-32-423	White	38.10	38.10	-	41.28	250	M71-R6000HF	BMP71
▲	BM71-29-423	White	38.10	12.70	-	15.88	5000	R6000HF	M611, BMP61, BMP71
▲	M71-31-423	White	38.10	25.40	-	28.58	250	M71-R6000HF	BMP71
▲	M71-2-423	White	50.80	6.35	-	53.98	100	M71-R6000HF	BMP71
▲	BM71-20-423	White	66.38	50.80	-	53.98	1000		M611, BMP61, BMP71
▲	M71-26-423	White	69.85	31.75	-	73.03	100	M71-R6000HF	BMP71
▲	M71-22-423	White	76.20	25.40	-	79.38	100	M71-R6000HF	BMP71
▲	M71-37-423	White	76.20	48.26	-	79.38	100	M71-R6000HF	BMP71
▲	M71-23-423	White	101.60	25.40	-	104.78	100	M71-R6000HF	BMP71
▲	M71-38-423	White	101.60	48.26	-	104.78	100	M71-R6000HF	BMP71
◎	M71C-500-423	White	12.70	-	15.24	-	1	M71-R6000HF	BMP71
B-428: Metallised Polyester									
▲	M71-15-428	Light Grey	25.40	6.99	-	10.16	750	M71-R4300	BMP71
▲	M71-17-428	Light Grey	25.40	12.70	-	15.88	500	M71-R4300	BMP71
▲	M71-20-428	Light Grey	25.40	50.80	-	53.98	100	M71-R4300	BMP71
▲	BM71-17-428	Light Grey	25.40	12.70	-	15.88	5000	R4300	M611, BMP61, BMP71
▲	BM71-20-428	Light Grey	25.40	50.80	-	53.98	1000	R4300	M611, BMP61, BMP71
▲	M71-29-428	Light Grey	38.10	12.70	-	15.88	500	M71-R4300	BMP71
▲	M71-35-428-PROP	Black on Light Grey	41.40	19.05	-	22.23	250	M71-R4300	BMP71
▲	M71-26-428	Light Grey	69.85	31.75	-	73.03	100	M71-R4300	BMP71
▲	M71-22-428	Light Grey	76.20	25.40	-	79.38	100	M71-R4300	BMP71
▲	M71-38-428	Light Grey	101.60	48.26	-	104.78	100	M71-R4300	BMP71
◎	M71C-500-428	Light Grey	12.70	-	15.24	-	1	M71-R4300	BMP71

Order references beginning with "B" indicate bulk rolls.

>>

▶ See pages 49 - 51 for a detailed material index.

Asset & component marking

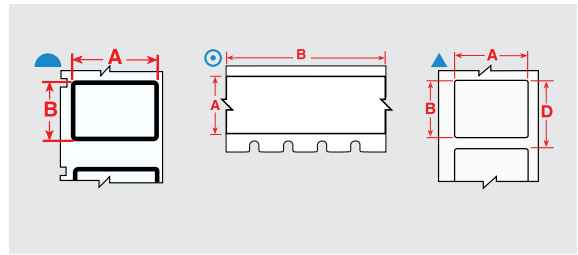

Rating and name plate labels (Continued)

For smooth, high energy surfaces (Continued)

Diagram	Order Reference	Colour	Label Width A (mm)	Label Height B (mm)	Label Length B (m)	Vertical Repeat D (mm)	Labels per Roll	Printer Ribbon Series	Printer Compatibility
B-430: Polyester									
▲	M71-68-430	Transparent	6.10	3.18	-	9.53	750	M71-R6000HF	BMP71
▲	M71-71-430	Transparent	8.89	5.08	-	9.53	750	M71-R6000HF	BMP71
▲	M71-16-430	Transparent	25.40	9.53	-	12.70	500	M71-R6000HF	BMP71
▲	M71-17-430	Transparent	25.40	12.70	-	15.88	500	M71-R6000HF	BMP71
▲	M71-45-430	Transparent	38.10	9.53	-	12.70	500	M71-R6000HF	BMP71
⊙	M71C-375-430	Transparent	9.53	-	15.24	-	1	M71-R6000HF	BMP71
⊙	M71C-500-430	Transparent	12.70	-	15.24	-	1	M71-R6000HF	BMP71
⊙	M71C-1000-430	Transparent	25.40	-	15.24	-	1	M71-R6000HF	BMP71
⊙	M71C-1900-430	Transparent	48.26	-	15.24	-	1	M71-R6000HF	BMP71
B-488: Polyester									
▲	M71-80-488	White	19.05	22.86	-	28.58	250	M71-R4300	BMP71
▲	M71-97-488	White	22.86	22.86	-	28.58	250	M71-R4300	BMP71
▲	M71-81-488	White	48.26	6.35	-	9.53	750	M71-R4300	BMP71
B-529: Polypropylene									
⊙	M71C-1000-529	White	25.40	-	15.24	-	1	M71-R6000HF	BMP71
⊙	M71C-2000-529	White	50.80	-	15.24	-	1	M71-R6000HF	BMP71

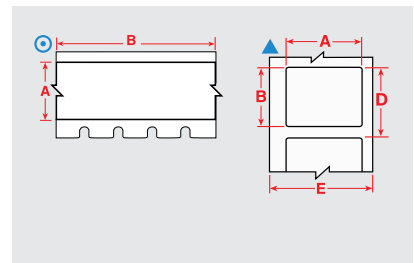
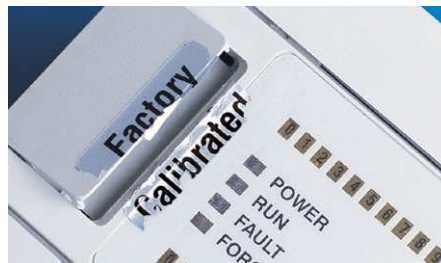

Security identification labels

Tamper-resistant tape destructs into tiny fragments when being removed, makes any attempts to remove the label very difficult and time consuming.

Diagram	Order Reference	Colour	Label Width A (mm)	Label Height B (mm)	Label Length B (m)	Vertical Repeat D (mm)	Labels per Roll	Printer Ribbon Series	Printer Compatibility
B-351: Tamper-resistant Vinyl									
▲	M71-17-351	White	25.40	12.70	-	15.88	500	M71-R6000HF	BMP71
▲	M71-20-351	White	25.40	50.80	-	53.98	100	M71-R6000HF	BMP71
▲	M71-31-351	White	38.10	25.40	-	28.58	250	M71-R6000HF	BMP71
▲	M71-37-351	White	76.20	48.26	-	79.38	100	M71-R6000HF	BMP71
B-362: Tamper-resistant Metallised Vinyl									
▲	M71-17-362	Silver	25.40	12.70	-	15.88	500	M71-R6000HF	BMP71
▲	M71-31-362	Silver	25.40	38.10	-	28.58	250	M71-R6000HF	BMP71
▲	M71-20-362	Silver	25.40	50.80	-	53.98	100	M71-R6000HF	BMP71
▲	M71-37-362	Silver	76.20	48.26	-	79.38	100	M71-R6000HF	BMP71
B-530: Tamper-resistant Vinyl									
⊙	M71C-500-530	White	12.70	-	15.24	-	1	M71-R6000HF	BMP71
⊙	M71C-1000-530	White	25.40	-	15.24	-	1	M71-R6000HF	BMP71
⊙	M71C-2000-530	White	50.80	-	15.24	-	1	M71-R6000HF	BMP71

Safety & facility identification

Pipe and valve marking / Safety signage

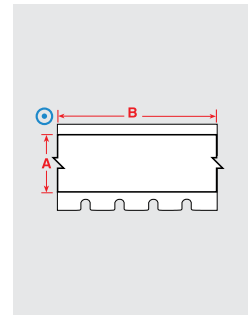

High performance indoor/outdoor vinyl

- Adheres to difficult low surface energy items, including: PVC piping, blow-molded equipment cases, ABS plastics, powder-coated surfaces and equipment made from recycled plastics.
- Excels at sticking to highly textured surfaces such as painted cinder block walls, finished uneven wood, textured plastics, rough-pipes and paper-jacketed pipes.
- 8 to 10** year outdoor durability average in temperatures from -40°C to 82°C, can be applied as low as -18 °C

Diagram	Order Reference	Colour	Finish	Label Width A (mm)	Label Length B (m)	Labels per Roll	Printer Ribbon Series	Printer Compatibility
B-595: Vinyl								
⊙	M71C-500-595-BK	Black	Gloss	12.70	15.24 m	1	M71-R4400-WT	BMP71
⊙	M71C-500-595-BL	Blue	Gloss	12.70	15.24 m	1	M71-R4400-WT	BMP71
⊙	M71C-500-595-BR	Brown	Gloss	12.70	15.24 m	1	M71-R4400-WT	BMP71
⊙	M71C-500-595-GD	Gold	Gloss	12.70	15.24 m	1	M71-R6000HF	BMP71
⊙	M71C-500-595-GN	Green	Gloss	12.70	15.24 m	1	M71-R4400-WT	BMP71
⊙	M71C-500-595-GY	Grey	Gloss	12.70	15.24 m	1	M71-R6000HF	BMP71
⊙	M71C-500-595-LB	Light Blue	Gloss	12.70	15.24 m	1	M71-R4400-WT	BMP71
⊙	M71C-500-595-OC	Ochre	Gloss	12.70	15.24 m	1	M71-R6000HF	BMP71
⊙	M71C-500-595-OR	Orange	Gloss	12.70	15.24 m	1	M71-R6000HF	BMP71
⊙	M71C-500-595-PK	Pink	Gloss	12.70	15.24 m	1	M71-R6000HF	BMP71
⊙	M71C-500-595-PL	Purple	Gloss	12.70	15.24 m	1	M71-R4400-WT	BMP71
⊙	M71C-500-595-RD	Red	Gloss	12.70	15.24 m	1	M71-R4400-WT	BMP71
⊙	M71C-500-595-SB	Sky Blue	Gloss	12.70	15.24 m	1	M71-R4400-WT	BMP71
⊙	M71C-500-595-TN	Tan	Gloss	12.70	15.24 m	1	M71-R6000HF	BMP71
⊙	M71C-500-595-CL	Transparent	Gloss	12.70	15.24 m	1	M71-R6000HF	BMP71
⊙	M71C-500-595-WT	White	Gloss	12.70	15.24 m	1	M71-R6000HF	BMP71
⊙	M71C-500-595-YL	Yellow	Gloss	12.70	15.24 m	1	M71-R6000HF	BMP71
⊙	M71C-1000-595-BK	Black	Gloss	25.40	15.24 m	1	M71-R4400-WT	BMP71
⊙	M71C-1000-595-BL	Blue	Gloss	25.40	15.24 m	1	M71-R4400-WT	BMP71
⊙	M71C-1000-595-BR	Brown	Gloss	25.40	15.24 m	1	M71-R4400-WT	BMP71
⊙	M71C-1000-595-GD	Gold	Gloss	25.40	15.24 m	1	M71-R6000HF	BMP71
⊙	M71C-1000-595-GN	Green	Gloss	25.40	15.24 m	1	M71-R4400-WT	BMP71
⊙	M71C-1000-595-GY	Grey	Gloss	25.40	15.24 m	1	M71-R6000HF	BMP71
⊙	M71C-1000-595-LB	Light Blue	Gloss	25.40	15.24 m	1	M71-R4400-WT	BMP71
⊙	M71C-1000-595-OC	Ochre	Gloss	25.40	15.24 m	1	M71-R6000HF	BMP71
⊙	M71C-1000-595-OR	Orange	Gloss	25.40	15.24 m	1	M71-R6000HF	BMP71
⊙	M71C-1000-595-PK	Pink	Gloss	25.40	15.24 m	1	M71-R6000HF	BMP71
⊙	M71C-1000-595-PL	Purple	Gloss	25.40	15.24 m	1	M71-R4400-WT	BMP71
⊙	M71C-1000-595-RD	Red	Gloss	25.40	15.24 m	1	M71-R4400-WT	BMP71
⊙	M71C-1000-595-SB	Sky Blue	Gloss	25.40	15.24 m	1	M71-R4400-WT	BMP71
⊙	M71C-1000-595-TN	Tan	Gloss	25.40	15.24 m	1	M71-R6000HF	BMP71
⊙	M71C-1000-595-CL	Transparent	Gloss	25.40	15.24 m	1	M71-R6000HF	BMP71
⊙	M71C-1000-595-WT	White	Gloss	25.40	15.24 m	1	M71-R6000HF	BMP71
⊙	M71C-1000-595-YL	Yellow	Gloss	25.40	15.24 m	1	M71-R6000HF	BMP71
⊙	M71C-2000-595-BK	Black	Gloss	50.80	15.24 m	1	M71-R4400-WT	BMP71
⊙	M71C-2000-595-BL	Blue	Gloss	50.80	15.24 m	1	M71-R4400-WT	BMP71
⊙	M71C-2000-595-BR	Brown	Gloss	50.80	15.24 m	1	M71-R4400-WT	BMP71
⊙	M71C-2000-595-GD	Gold	Gloss	50.80	15.24 m	1	M71-R6000HF	BMP71
⊙	M71C-2000-595-GN	Green	Gloss	50.80	15.24 m	1	M71-R4400-WT	BMP71
⊙	M71C-2000-595-GY	Grey	Gloss	50.80	15.24 m	1	M71-R6000HF	BMP71
⊙	M71C-2000-595-LB	Light Blue	Gloss	50.80	15.24 m	1	M71-R4400-WT	BMP71

>>

**Average expected outdoor life of product will depend on user definition of failure, climatic conditions, mounting techniques and material colour. The up to 8 to 10 year outdoor durability applies to the vinyl label stock only; ribbon durability will vary. A polyester overlamine is recommended for harsh environments - long term exposure to wind and rain.

Pipe and valve marking / Safety signage

High performance indoor/outdoor vinyl (Continued)

Diagram	Order Reference	Colour	Finish	Label Width A (mm)	Label Length B (m)	Labels per Roll	Printer Ribbon Series	Printer Compatibility
⊙	M71C-2000-595-OC	Ochre	Gloss	50.80	15.24 m	1	M71-R6000HF	BMP71
⊙	M71C-2000-595-OR	Orange	Gloss	50.80	15.24 m	1	M71-R6000HF	BMP71
⊙	M71C-2000-595-PK	Pink	Gloss	50.80	15.24 m	1	M71-R6000HF	BMP71
⊙	M71C-2000-595-PL	Purple	Gloss	50.80	15.24 m	1	M71-R4400-WT	BMP71
⊙	M71C-2000-595-RD	Red	Gloss	50.80	15.24 m	1	M71-R4400-WT	BMP71
⊙	M71C-2000-595-SB	Sky Blue	Gloss	50.80	15.24 m	1	M71-R4400-WT	BMP71
⊙	M71C-2000-595-TN	Tan	Gloss	50.80	15.24 m	1	M71-R6000HF	BMP71
⊙	M71C-2000-595-CL	Transparent	Gloss	50.80	15.24 m	1	M71-R6000HF	BMP71
⊙	M71C-2000-595-WT	White	Gloss	50.80	15.24 m	1	M71-R6000HF	BMP71
⊙	M71C-2000-595-YL	Yellow	Gloss	50.80	15.24 m	1	M71-R6000HF	BMP71

Food processing equipment marking

ToughWash series labels

- Durable label construction resists harsh washdown environments and has been tested at washdown temperatures up to 80°C (175° F) and pressures up to 1500 PSI.
- B-854 is a metal detectable version, capable of being detected by commercially available metal detectors.



Diagram	Order Reference	Colour	Finish	Label Width A (mm)	Label Length B (m)	Printer Ribbon Series	Printer Compatibility
B-854: Metal Detectable Polyester							
⊙	BM71C-1000-854-YL	Yellow	Matt	25.40	22.86 m	M71-R6000HF	BMP71
⊙	BM71C-1000-854-WT	White	Matt	25.40	22.86 m	M71-R6000HF	BMP71
⊙	BM71C-2000-854-YL	Yellow	Matt	50.80	22.86 m	M71-R6000HF	BMP71
⊙	BM71C-2000-854-WT	White	Matt	50.80	22.86 m	M71-R6000HF	BMP71
⊙	BM71C-2000-854-WAR	Black, Orange on White	Matt	50.80	22.86 m	M71-R6000HF	BMP71
⊙	BM71C-2000-854-DAN	White on Red	Matt	50.80	22.86 m	M71-R6000HF	BMP71
⊙	BM71C-2000-854-CAU	Black, Yellow on White	Matt	50.80	22.86 m	M71-R6000HF	BMP71
B-855: Polyester							
⊙	BM71C-1000-855-YL	Yellow	Matt	25.40	22.86 m	M71-R6000HF	BMP71
⊙	BM71C-1000-855-WT	White	Matt	25.40	22.86 m	M71-R6000HF	BMP71
⊙	BM71C-2000-855-YL	Yellow	Matt	50.80	22.86 m	M71-R6000HF	BMP71
⊙	BM71C-2000-855-WT	White	Matt	50.80	22.86 m	M71-R6000HF	BMP71
⊙	BM71C-2000-855-WAR	Black, Orange on White	Matt	50.80	22.86 m	M71-R6000HF	BMP71
⊙	BM71C-2000-855-DAN	White on Red	Matt	50.80	22.86 m	M71-R6000HF	BMP71
⊙	BM71C-2000-855-CAU	Black, Yellow on White	Matt	50.80	22.86 m	M71-R6000HF	BMP71

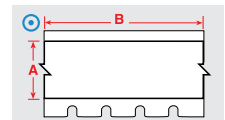

Order references beginning with "B" indicate bulk rolls.

Exit & directional signs

Photoluminescent polyester tapes

Glow-in-the-dark material. Ideal for exit and directional signs, identification of fire alarms and extinguishers, low location egress pathway markings, and directional systems for escape or evacuation routes.



Diagram	Order Reference	Colour	Finish	Label Width A (mm)	Label Length B (m)	Printer Ribbon Series	Printer Compatibility
B-582: Phosphorescent Polyester							
⊙	BM71C-1000-582	Photoluminescent	Gloss	25.40	22.86 m	M71-R6000HF	BMP71
⊙	BM71C-2000-582	Photoluminescent	Gloss	50.80	22.86 m	M71-R6000HF	BMP71

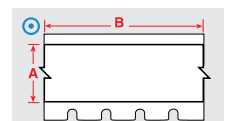

Order references beginning with "B" indicate bulk rolls.

▶ See pages 49 - 51 for a detailed material index.

Safety & facility identification

Maintenance

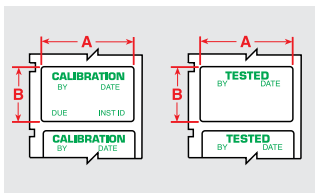

Pre-printed labels

- BMP71 printable labels with pre-printed headers allow customers to print variable information next to highly visible titles.

Order Reference	Legend	Colour	Finish	Label Width A (mm)	Label Height B (mm)	Repeat (mm)	Labels per Roll	Printer Ribbon Series	Printer Compatibility
B-428: Metallised Polyester									
M71-30-428-CALI	CALIBRATION	Green on Grey	Matt	19.05	38.10	22.23	250	M71-R4300	BMP71
B-423: Polyester									
M71-30-423-TEST	TESTED	Green on White	Gloss	19.05	38.10	22.23	250	M71-R6000HF	BMP71

Area and pathway marking

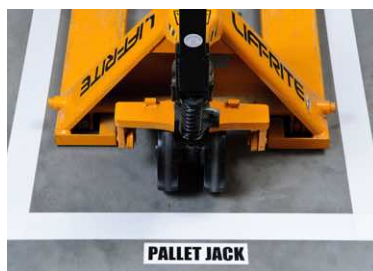

ToughStripe area marking tape

- Create custom-printed floor labels, with easy 3-step process: print label, position on floor, apply overlaminates.
- Each kit includes 1 roll of B-483 tape and 1 roll of B-634 overlaminates.

Diagram	Order Reference	Colour	Finish	Label Width A (mm)	Label Length B (m)	Printer Ribbon Series	Printer Compatibility
B-483A/B-634: Polyester with Polyester Overlaminates							
⊙	M71-1000-483-BK-KT	Black	Gloss	25.40	15.24 m	M71-R4400-WT	BMP71
⊙	M71-1000-483-BL-KT	Blue	Gloss	25.40	15.24 m	M71-R6000HF	BMP71
⊙	M71-1000-483-GN-KT	Green	Gloss	25.40	15.24 m	M71-R6000HF	BMP71
⊙	M71-1000-483-OR-KT	Orange	Gloss	25.40	15.24 m	M71-R6000HF	BMP71
⊙	M71-1000-483-RD-KT	Red	Gloss	25.40	15.24 m	M71-R6000HF	BMP71
⊙	M71-1000-483-WT-KT	White	Gloss	25.40	15.24 m	M71-R6000HF	BMP71
⊙	M71-1000-483-YL-KT	Yellow	Gloss	25.40	15.24 m	M71-R6000HF	BMP71
⊙	M71-2000-483-BK-KT	Black	Gloss	50.80	15.24 m	M71-R4400-WT	BMP71
⊙	M71-2000-483-BL-KT	Blue	Gloss	50.80	15.24 m	M71-R6000HF	BMP71
⊙	M71-2000-483-GN-KT	Green	Gloss	50.80	15.24 m	M71-R6000HF	BMP71
⊙	M71-2000-483-OR-KT	Orange	Gloss	50.80	15.24 m	M71-R6000HF	BMP71
⊙	M71-2000-483-RD-KT	Red	Gloss	50.80	15.24 m	M71-R6000HF	BMP71
⊙	M71-2000-483-WT-KT	White	Gloss	50.80	15.24 m	M71-R6000HF	BMP71
⊙	M71-2000-483-YL-KT	Yellow	Gloss	50.80	15.24 m	M71-R6000HF	BMP71

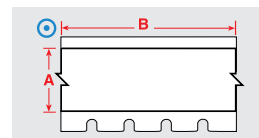

Safety signs and labels

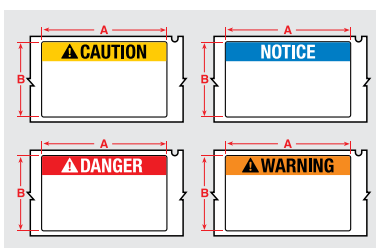

Pre-printed labels

BMP71 printable labels with pre-printed headers allow customers to print variable information next to highly visible titles.

Order Reference	Legend	Colour	Finish	Label Width A (mm)	Label Height B (mm)	Repeat (mm)	Labels per Roll	Printer Ribbon Series	Printer Compatibility
B-483A: Polyester									
M71-38-483-CAUT	CAUTION	Black, Yellow on White	Gloss	101.60	48.26	104.78	100	M71-R6000HF	BMP71
M71-38-483-NOTI	NOTICE	Blue on White	Gloss	101.60	48.26	104.78	100	M71-R6000HF	BMP71
M71-38-483-DANG	DANGER	Red on White	Gloss	101.60	48.26	104.78	100	M71-R6000HF	BMP71
M71-38-483-WARN	WARNING	Black, Orange on White	Gloss	101.60	48.26	104.78	100	M71-R6000HF	BMP71

Safety signs and labels



Reflective tapes

The reflective quality of this material makes it ideal for reading labels in low light conditions (with flashlights).

Diagram	Order Reference	Colour	Finish	Label Width A (mm)	Label Length B (m)	Printer Ribbon Series	Printer Compatibility
B-584: Reflective Tape							
⊙	BM71C-1000-584-OR	Orange	Gloss	25.40	22.86 m	M71-R6000HF	BMP71
⊙	BM71C-1000-584-WT	White	Gloss	25.40	22.86 m	M71-R6000HF	BMP71
⊙	BM71C-1000-584-YL	Yellow	Gloss	25.40	22.86 m	M71-R6000HF	BMP71
⊙	BM71C-2000-584-OR	Orange	Gloss	50.80	22.86 m	M71-R6000HF	BMP71
⊙	BM71C-2000-584-WT	White	Gloss	50.80	22.86 m	M71-R6000HF	BMP71
⊙	BM71C-2000-584-YL	Yellow	Gloss	50.80	22.86 m	M71-R6000HF	BMP71

Order references with "C" (e.g. M71C) indicate continuous. Order references beginning with "B" indicate bulk rolls.

Lean warehouse labels



Paper labels

- Economical choice for light duty general id.
- White finish and mattx topcoat.
- Excellent contrast and smear resistance for barcode printing.

Diagram	Order Reference	Colour	Label Width A (mm)	Label Height B (mm)	Vertical Repeat D (mm)	Labels per Roll	Printer Ribbon Series	Printer Compatibility
B-424: Paper								
▲	M71-20-424	White	25.40	50.80	53.98	100	M71-R4300	BMP71
▲	BM71-20-424	White	25.40	50.80	53.98	1000	R4300	M611, BMP61, BMP71

Order references beginning with "B" indicate bulk rolls.



Repositionable vinyl

Best choice for indoor marking where frequent repositioning is required, such as shelves. Special adhesive allows easy removal of label to re-apply again and again.

Diagram	Order Reference	Colour	Finish	Label Width A (mm)	Label Length B (m)	Printer Ribbon Series	Printer Compatibility
B-581: Vinyl							
⊙	M71C-500-581-WT	White	Gloss	12.70	15.24 m	M71-R6000HF	BMP71
⊙	M71C-500-581-YL	Yellow	Gloss	12.70	15.24 m	M71-R6000HF	BMP71
⊙	M71C-1000-581-WT	White	Gloss	25.40	15.24 m	M71-R6000HF	BMP71
⊙	M71C-1000-581-YL	Yellow	Gloss	25.40	15.24 m	M71-R6000HF	BMP71
⊙	M71C-2000-581-WT	White	Gloss	50.80	15.24 m	M71-R6000HF	BMP71
⊙	M71C-2000-581-YL	Yellow	Gloss	50.80	15.24 m	M71-R6000HF	BMP71

▶ See pages 49 - 51 for a detailed material index.

Circuit board marking

Thermal transfer printable products circuit board process chart

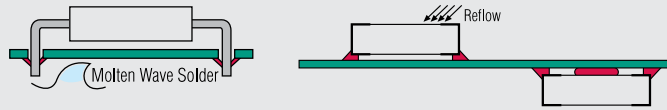

	Through Hole Technology		Surface Mount Technology (SMT)	
	Top	Bottom	Top or Bottom	After Process
B-717, B-718, B-719, B-724, B-727	Yes	Yes	Yes	Yes
B-422, B-423, B-430, B-437, B-459, B-473, B-488	Yes*	No	No	Yes

*In extreme high temperature, testing of these materials is recommended



Polyester labels

Various types of high resistant polyester materials for relays, solenoids, PCB's, electronic components and more.

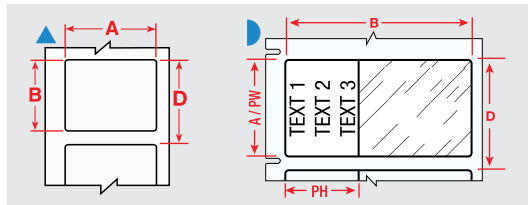

Diagram	Order Reference	Colour	Label Width A (mm)	Label Height B (mm)	Vertical Repeat D (mm)	Labels per Roll	Printer Ribbon Series	Printer Compatibility
B-423: Polyester								
▲	M71-1-423	White	6.35	6.35	9.53	750	M71-R6000HF	BMP71
▲	M71-3-423	White	9.53	9.53	12.70	500	M71-R6000HF	BMP71
▲	M71-4-423	White	10.16	10.16	13.34	500	M71-R6000HF	BMP71
▲	M71-5-423	White	12.70	5.08	8.26	750	M71-R6000HF	BMP71
▲	M71-6-423	White	12.70	6.99	10.16	750	M71-R6000HF	BMP71
▲	M71-7-423	White	12.70	12.70	15.88	500	M71-R6000HF	BMP71
▲	BM71-7-423	White	12.70	12.70	15.88	5000	R6000HF	M611, BMP61, BMP71
▲	M71-9-423	White	16.51	5.08	8.26	750	M71-R6000HF	BMP71
▲	M71-10-423	White	19.05	6.35	9.53	750	M71-R6000HF	BMP71
▲	M71-13-423	White	22.86	6.35	9.53	750	M71-R6000HF	BMP71
▲	M71-14-423	White	25.40	4.75	8.26	750	M71-R6000HF	BMP71
▲	M71-15-423	White	25.40	6.99	10.16	750	M71-R6000HF	BMP71
▲	BM71-17-423	White	25.40	12.70	15.88	5000	R6000HF	M611, BMP61, BMP71
▲	BM71-16-423	White	25.40	9.53	12.70	5000	R6000HF	M611, BMP61, BMP71
▲	BM71-19-423	White	25.40	25.40	28.58	2500	R6000HF	M611, BMP61, BMP71
▲	M71-16-423	White	25.40	9.53	12.70	500	M71-R6000HF	BMP71
▲	M71-17-423	White	25.40	12.70	15.88	500	M71-R6000HF	BMP71
▲	M71-19-423	White	25.40	25.40	28.58	250	M71-R6000HF	BMP71
▲	M71-25-423	White	31.75	6.35	9.53	750	M71-R6000HF	BMP71
▲	M71-27-423	White	38.10	3.18	6.35	750	M71-R6000HF	BMP71
▲	M71-28-423	White	38.10	6.35	9.53	750	M71-R6000HF	BMP71
▲	M71-29-423	White	38.10	12.70	15.88	500	M71-R6000HF	BMP71
▲	M71-32-423	White	38.10	38.10	41.28	250	M71-R6000HF	BMP71
▲	BM71-29-423	White	38.10	12.70	15.88	5000	R6000HF	M611, BMP61, BMP71
▲	M71-31-423	White	38.10	25.40	28.58	250	M71-R6000HF	BMP71

Order references beginning with "B" indicate bulk rolls.

>>

Circuit board marking

Polyester labels (continued)

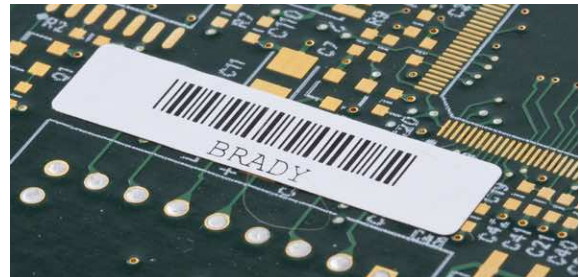
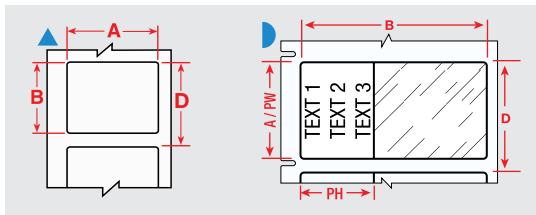

Diagram	Order Reference	Colour	Label Width A (mm)	Label Height B (mm)	Vertical Repeat D (mm)	Labels per Roll	Printer Ribbon Series	Printer Compatibility
B-459: Polyester								
▲	M71-20-459	White	25.40	50.80	53.98	100	M71-R6000HF	BMP71
▲	M71-29-459	White	38.10	12.70	15.88	500	M71-R6000HF	BMP71
▲	M71-30-459	White	38.10	19.05	22.23	250	M71-R6000HF	BMP71
B-473: Static Dissipative Polyester								
▲	M71-6-473	White	12.70	6.99	10.16	750	M71-R6000HF	BMP71
▲	M71-9-473	White	16.51	5.08	8.26	750	M71-R6000HF	BMP71
▲	M71-10-473	White	19.05	6.35	9.53	750	M71-R6000HF	BMP71
▲	M71-16-473	White	25.40	9.53	12.70	500	M71-R6000HF	BMP71
▲	M71-17-473	White	25.40	12.70	15.88	500	M71-R6000HF	BMP71
◐	M71-28-473	White	38.10	6.35	9.53	750	M71-R6000HF	BMP71

Polyimide labels

Various types of high resistant polyimide materials for relays, solenoids, PCB's and electronic components.

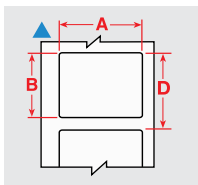

Diagram	Order Reference	Colour	Label Width A (mm)	Label Height B (mm)	Vertical Repeat D (mm)	Labels per Roll	Printer Ribbon Series	Printer Compatibility
B-717: Polyimide								
▲	M71-14-717	White	25.40	4.75	8.26	750	M71-R6000HF	BMP71
▲	M71-2-717	White	50.80	6.35	53.98	100	M71-R6000HF	BMP71
B-718: Polyimide								
▲	M71-4-718	White	10.16	10.16	13.34	500	M71-R6000HF	BMP71
▲	M71-9-718	White	16.51	5.08	8.26	750	M71-R6000HF	BMP71
▲	M71-25-718	White	31.75	6.35	9.53	750	M71-R6000HF	BMP71
B-724: Polyimide								
▲	M71-9-724	Amber	16.51	5.08	8.26	750	M71-R4300	BMP71
▲	M71-13-724	Amber	22.86	6.35	9.53	750	M71-R4300	BMP71
▲	M71-16-724	Amber	25.40	9.53	12.70	500	M71-R4300	BMP71
▲	M71-17-724	Amber	25.40	12.70	15.88	500	M71-R4300	BMP71
▲	M71-28-724	Amber	38.10	6.35	9.53	750	M71-R4300	BMP71
B-727: Polyimide								
▲	M71-10-727	White	19.05	6.35	9.53	750	M71-R6000HF	BMP71
▲	M71-16-727	White	25.40	9.53	12.70	500	M71-R6000HF	BMP71

▶ See pages 49 - 51 for a detailed material index.

Specimen tracking identification



Straw & rod labelling

Brady offers a range of labels designed to fit the small surface area of straws and rods and will withstand long-term storage.

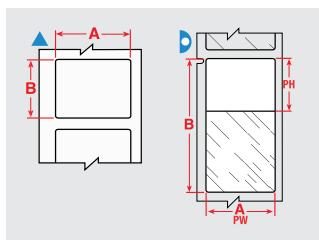

Labels are shown per vial / tube size and in order of label width.

The background colours in the Order Reference column represent the material colour.

Diagram	Material	Special Properties	Label Width A (mm)	Label Height B (mm)	Printable Area Width PW (mm)	Printable Area Height PH (mm)	Order Reference	Printer Compatibility	Printer Ribbon Series	Labels per Roll
0.25 ml										
▶	B-427	F N S	25.40	25.40	25.40	9.53	BM71-19-427	M611, BMP61, BMP71	R4300	2500
▶	B-461	F N A H S L	25.40	25.40	25.40	9.53	M71-19-461	BMP71	M71-R4300	250
▶	B-427	F N S	25.40	25.40	25.40	9.53	M71-19-427	BMP71	M71-R4300	250
▶	B-427	F N S	25.40	25.40	25.40	9.53	M71-19-427-YL	BMP71	M71-R4300	250
0.25 ml Straw										
▲	B-492	F N H L	25.40	25.40	-	-	M71-19-492	BMP71	M71-R6400	250
0.3										
▶	B-427	F N S	25.40	63.50	25.40	19.05	BM71-21-427	M611, BMP61, BMP71	R4300	1000
▶	B-427	F N S	25.40	63.50	25.40	19.05	M71-21-427	BMP71	M71-R4300	100
▶	B-427	F N S	25.40	63.50	25.40	19.05	M71-21-427-YL	BMP71	M71-R4300	100

Order references beginning with "B" indicate bulk rolls.



Vial tops

Save time by using the Vial and Vial top combination labels - print your information in one go.

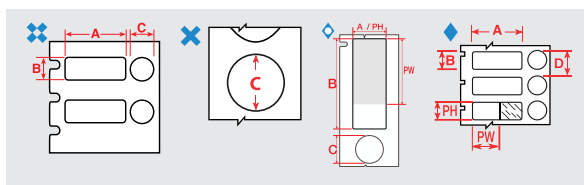

Diagram	Material	Special Properties	Label Width A (mm)	Label Height B (mm)	Diameter C (mm)	Printable Area Width PW (mm)	Printable Area Height PH (mm)	Order Reference	Printer Compatibility	Printer Ribbon Series	Labels per Roll
0.5 - 0.7 ml											
✦	B-499	F A	25.40	9.53	9.53	25.40	9.53	M71-98-499	BMP71	M71-R4300	500
0.6 - 1.5 ml											
✕	B-499	F A	-	-	9.53	-	9.53	M71-82-499	BMP71	M71-R4300	500
1.0 - 2.0 ml											
✕	B-499	F A	-	-	12.70	-	12.70	M71-83-499	BMP71	M71-R4300	500
◇	B-461	F A H S L	15.24	41.28	12.70	15.24	30.00	M71-116-461	BMP71	M71-R6200	150
✦	B-492	F H L	25.40	12.70	9.53	-	-	M71-118-492	BMP71	M71-R6400	500
◆	B-461	F A H S L	40.00	15.00	9.53	30.00	15.00	M71-101-461	BMP71	M71-R6200	250
1.0 - 8.0 ml											
✦	B-499	F A	22.86	12.70	12.70	-	-	M71-126-499	BMP71	M71-R4300	500

F Freezer environment **N** Liquid nitrogen environment **A** Autoclave environment **H** Hot water bath (100°C) **S** Self-laminating label **L** Low-profile (extremely thin) label **R** Removable

▶ See pages 49 - 51 for a detailed material index.

Specimen tracking identification

Vial / tube labels

Brady's vial and test tube labels are designed to withstand extreme laboratory solvents like Xylene, Ethanol, Alcohol and DMSO, ensuring that the specimen identification is always legible - and will not smear, fade or fall off.

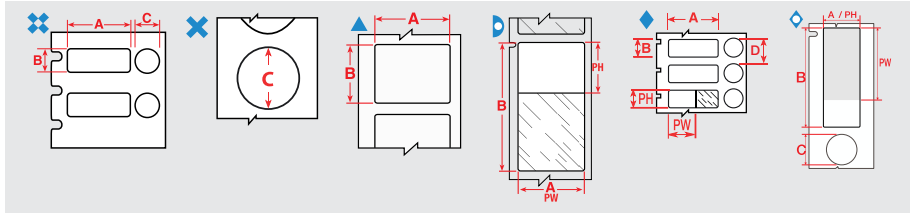

Labels are shown per vial / tube size and in order of label width.

The background colours in the Order Reference column represent the material colour.

Diagram	Material	Special Properties	Label Width A (mm)	Label Height B (mm)	Label Length B (m)	Diameter C (mm)	Printable Area Width PW (mm)	Printable Area Height PH (mm)	Order Reference	Printer Compatibility	Printer Ribbon Series	Labels per Roll
0.5 - 0.7 ml												
▲	B-498	F R	9.53	25.40	-	-	9.53	25.40	M71-16-498	BMP71	M71-R6200	500
▷	B-461	F N A H S L	9.53	45.72	-	-	9.53	19.05	M71-73-461	BMP71	M71-R6200	250
▲	B-498	F R	12.70	19.05	-	-	12.70	19.05	BM71-11-498	M611, BMP61, BMP71	R6200	5000
▲	B-498	F R	12.70	19.05	-	-	12.70	19.05	M71-11-498	BMP71	M71-R6200	500
▲	B-492	F N H L	25.40	9.53	-	-	-	-	M71-16-492	BMP71	M71-R6400	500
⊕	B-499	F A	25.40	9.53	-	9.53	25.40	9.53	M71-98-499	BMP71	M71-R4300	500
0.6 - 1.5 ml												
⊗	B-499	F A	-	-	-	12.70	-	12.70	M71-82-499	BMP71	M71-R4300	500
1.0 - 2.0 ml												
⊗	B-499	F A	-	-	-	12.70	-	12.70	M71-83-499	BMP71	M71-R4300	500
▷	B-461	F N A H S L	15.24	38.10	-	-	15.24	33.00	M71-100-461	BMP71	M71-R6200	500
◇	B-461	F A H S L	15.24	41.28	-	12.70	15.24	30.00	M71-116-461	BMP71	M71-R6200	150
⊕	B-492	F H L	25.40	12.70	-	9.53	-	-	M71-118-492	BMP71	M71-R6400	500
▷	B-461	F N A H S L	25.40	44.45	-	-	25.40	25.40	M71-106-461	BMP71	M71-R6200	250
◇	B-461	F A H S L	40.00	15.00	-	9.53	30.00	15.00	M71-101-461	BMP71	M71-R6200	250
1.0 - 8.0 ml												
▷	B-461	F N A H S L	15.24	41.28	-	-	15.24	25.40	M71-76-461	BMP71	M71-R6200	500
▷	B-461	F N A H S L	15.24	66.68	-	-	15.24	25.40	M71-86-461	BMP71	M71-R6200	100
⊕	B-499	F A	22.86	12.70	-	12.70	-	-	M71-126-499	BMP71	M71-R4300	500
▷	B-461	F N A H S L	25.40	66.68	-	-	25.40	25.40	M71-115-461	BMP71	M71-R6200	100
▲	B-490	F N H L	41.28	15.24	-	-	-	-	M71-76-490	BMP71	M71-R4300	500
▲	B-492	F N H L	48.26	25.40	-	-	-	-	M71-78-492	BMP71	M71-R6400	250
2.0 - 4.0 ml												
▷	B-461	F N A H S L	15.24	48.26	-	-	15.24	40.00	M71-107-461	BMP71	M71-R6200	500
12.0 - 24.0 ml												
▲	B-498	F R	12.70	38.10	-	-	12.70	38.10	BM71-29-498	M611, BMP61, BMP71	R6200	5000
▲	B-498	F R	38.10	12.70	-	-	38.10	12.70	M71-29-498	BMP71	M71-R6200	500
50.0 ml												
▷	B-427	F N S	19.05	38.10	-	-	19.05	12.70	BM71-30-427	M611, BMP61, BMP71	R4300	2500
▲	B-498	F R	25.40	12.70	-	-	25.40	12.70	M71-17-498	BMP71	M71-R6200	500
▲	B-498	F R	25.40	38.10	-	-	25.40	38.10	M71-31-498	BMP71	M71-R6200	250
▲	B-427	F N S	38.10	19.05	-	-	38.10	19.05	M71-30-427-AW	BMP71	M71-R4300	250

Order references beginning with "B" indicate bulk rolls. *AW = All White / no transparent area.

F Freezer environment N Liquid nitrogen environment A Autoclave environment H Hot water bath (100°C) S Self-laminating label L Low-profile (extremely thin) label R Removable

Specimen tracking identification



Conical & large tube labelling

Brady offers several sample identification labels which are perfect to identify conicals. They are easy to handle, have great flexibility and easily wrap around curved sample containers. Your sample identification label will remain attached and legible, even when the sample is stored in a freezer, in liquid nitrogen or heated in an autoclave.

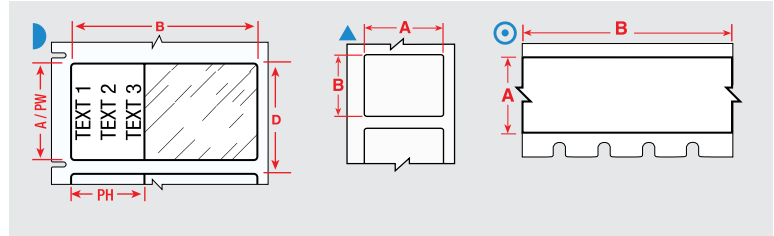

Labels are shown per vial / tube size and in order of label width.

The background colours in the Order Reference column represent the material colour.

Diagram	Material	Special Properties	Label Width A (mm)	Label Height B (mm)	Label Length B (m)	Diameter C (mm)	Printable Area Width PW (mm)	Printable Area Height PH (mm)	Order Reference	Printer Compatibility	Printer Ribbon Series	Labels per Roll
1.0 - 8.0 ml												
▲	B-490	F N H L	41.28	15.24	-	-	-	-	M71-76-490	BMP71	M71-R4300	500
▲	B-499	F N A	48.26	25.40	-	-	48.26	25.40	M71-78-499	BMP71	M71-R4300	250
1.5 ml												
◎	B-430	F A H	12.70	-	15.24	-	-	-	M71C-500-430	BMP71	M71-R6000HF	1
12.0 - 24.0 ml												
▲	B-498	F R	12.70	38.10	-	-	12.70	38.10	BM71-29-498	M611, BMP61, BMP71	R6200	5000
▲	B-499	F N A	12.70	38.10	-	-	12.70	38.10	M71-29-499	BMP71	M71-R4300	500
▲	B-498	F R	38.10	12.70	-	-	38.10	12.70	M71-29-498	BMP71	M71-R6200	500
50.0 ml												
▲	B-423	F A H	12.70	12.70	-	-	12.70	12.70	BM71-7-423	M611, BMP61, BMP71	R6000HF	5000
▲	B-423	F A H	12.70	12.70	-	-	12.70	12.70	M71-7-423	BMP71	M71-R6000HF	500
▶	B-427	F N S	19.05	38.10	-	-	19.05	12.70	BM71-30-427	M611, BMP61, BMP71	R4300	2500
▲	B-499	F N A	19.05	38.10	-	-	19.05	38.10	M71-30-499	BMP71	M71-R4300	250
▲	B-423	F A H	25.40	4.75	-	-	25.40	4.75	M71-14-423	BMP71	M71-R6000HF	750
▲	B-423	F A H	25.40	6.99	-	-	25.40	6.99	M71-15-423	BMP71	M71-R6000HF	750
▲	B-492	F N H L	25.40	12.70	-	-	-	-	M71-17-492	BMP71	M71-R6400	500
▲	B-423	F A H	25.40	12.70	-	-	25.40	12.70	M71-17-423	BMP71	M71-R6000HF	500
▲	B-430	F A H	25.40	12.70	-	-	25.40	12.70	M71-17-430	BMP71	M71-R6000HF	500
▲	B-498	F R	25.40	12.70	-	-	25.40	12.70	M71-17-498	BMP71	M71-R6200	500
▶	B-461	F N A H S L	25.40	38.10	-	-	25.40	12.70	M71-31-461	BMP71	M71-R6200	250
▲	B-498	F R	25.40	38.10	-	-	25.40	38.10	M71-31-498	BMP71	M71-R6200	250
▲	B-499	F N A	25.40	38.10	-	-	25.40	38.10	M71-31-499	BMP71	M71-R4300	250
▲	B-423	F A H	25.40	50.80	-	-	25.40	50.80	M71-20-423	BMP71	M71-R6000HF	100
▲	B-427	F N S	38.10	19.05	-	-	38.10	19.05	M71-30-427-AW	BMP71	M71-R4300	250
▲	B-423	F A H	38.10	25.40	-	-	38.10	25.40	M71-31-423	BMP71	M71-R6000HF	250
▲	B-423	F A H	66.38	50.80	-	-	50.80	25.40	BM71-20-423	M611, BMP61, BMP71	R6000HF	1000
▲	B-423	F A H	76.20	25.40	-	-	76.20	25.40	M71-22-423	BMP71	M71-R6000HF	100

Order references beginning with "B" indicate bulk rolls. *AW = All White / no transparent area.

F Freezer environment N Liquid nitrogen environment A Autoclave environment H Hot water bath (100°C) S Self-laminating label L Low-profile (extremely thin) label R Removable

▶ See pages 49 - 51 for a detailed material index.

Specimen process marking

Centrifuge / microcentrifuge labels

- Brady offers a wide range of Centrifuge, Eppendorf and PCR Labels.
- When applying a self-laminating label, we recommend you avoid touching the adhesive side of the label when wrapping it around a vial or tube, to ensure maximum adhesion.

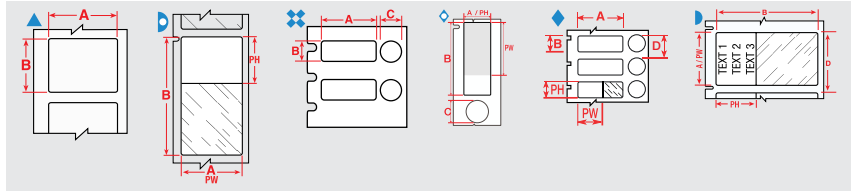

Labels are shown per vial / tube size and in order of label width.

The background colours in the Order Reference column represent the material colour.

Diagram	Material	Special Properties	Label Width A (mm)	Label Height B (mm)	Label Length B (m)	Diameter C (mm)	Printable Area Width PW (mm)	Printable Area Height PH (mm)	Order Reference	Printer Compatibility	Printer Ribbon Series	Labels per Roll
0.5 - 0.7 ml												
▲	B-498	F R	9.53	25.40	-	-	9.53	25.40	M71-16-498	BMP71	M71-R6200	500
▲	B-499	F N A	9.53	25.40	-	-	9.53	25.40	M71-16-499	BMP71	M71-R4300	500
▷	B-461	F N A H S L	9.53	45.72	-	-	9.53	19.05	M71-73-461	BMP71	M71-R6200	250
▲	B-498	F R	12.70	19.05	-	-	12.70	19.05	BM71-11-498	M611, BMP61, BMP71	R6200	5000
▲	B-498	F R	12.70	19.05	-	-	12.70	19.05	M71-11-498	BMP71	M71-R6200	500
▲	B-499	F N A	12.70	19.05	-	-	12.70	19.05	M71-11-499	BMP71	M71-R4300	500
⚡	B-499	F A	25.40	9.53	-	9.53	25.40	9.53	M71-98-499	BMP71	M71-R4300	500
0.6 ml												
▲	B-499	F N A	22.86	12.70	-	-	22.86	12.70	M71-84-499	BMP71	M71-R4300	500
1.0 - 2.0 ml												
▷	B-461	F N A H S L	15.24	38.10	-	-	15.24	33.00	M71-100-461	BMP71	M71-R6200	500
◇	B-461	F A H S L	15.24	41.28	-	12.70	15.24	30.00	M71-116-461	BMP71	M71-R6200	150
▷	B-461	F N A H S L	25.40	44.45	-	-	25.40	25.40	M71-106-461	BMP71	M71-R6200	250
◆	B-461	F A H S L	40.00	15.00	-	9.53	30.00	15.00	M71-101-461	BMP71	M71-R6200	250
1.0 - 8.0 ml												
▷	B-461	F N A H S L	15.24	41.28	-	-	15.24	25.40	M71-76-461	BMP71	M71-R6200	500
▷	B-461	F N A H S L	15.24	66.68	-	-	15.24	25.40	M71-86-461	BMP71	M71-R6200	100
▷	B-461	F N A H S L	25.40	66.68	-	-	25.40	25.40	M71-115-461	BMP71	M71-R6200	100
▲	B-490	F N H L	41.28	15.24	-	-	-	-	M71-76-490	BMP71	M71-R4300	500
▷	B-461	F N A H S L	66.68	25.40	-	-	25.40	25.40	BM71-75-461	M611, BMP61, BMP71	R6200	1000
2.0 - 4.0 ml												
▷	B-461	F N A H S L	15.24	48.26	-	-	15.24	40.00	M71-107-461	BMP71	M71-R6200	500
50.0 ml												
▷	B-427	F N S	19.05	38.10	-	-	19.05	12.70	BM71-30-427	M611, BMP61, BMP71	R4300	2500
▷	B-461	F N A H S L	25.40	38.10	-	-	25.40	12.70	M71-31-461	BMP71	M71-R6200	250
▲	B-427	F N S	38.10	19.05	-	-	38.10	19.05	M71-30-427-AW	BMP71	M71-R4300	250

Order references beginning with "B" indicate bulk rolls. *AW = All White / no transparent area.

Slide labels

Brady offers labels specifically designed to identify slides and to resist exposure to harsh chemicals during the slide staining process. They perform well in the hematoxylin and eosin slide staining process and offer superior chemical resistance also useful in other laboratory contexts.

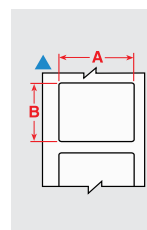

Diagram	Material	Special Properties	Label Width A (mm)	Label Height B (mm)	Order Reference	Printer Compatibility	Printer Ribbon Series	Labels per Roll
▲	B-488	F A	19.05	22.86	M71-80-488	BMP71	M71-R4300	250
▲	B-488	F A	22.86	22.86	M71-97-488	BMP71	M71-R4300	250
▲	B-481	F H	22.86	22.86	M71-97-481	BMP71	M71-R6400	250

F Freezer environment N Liquid nitrogen environment A Autoclave environment H Hot water bath (100°C) S Self-laminating label L Low-profile (extremely thin) label R Removable

Laboratory identification

Specimen storage identification

Cryo tubes & vials



- Brady offers a range of labels designed specifically to identify laboratory samples for cryo storage.
- These labels can be applied to room temperature or to already frozen samples, albeit with a small overlap.
- The label will remain legible and will stick to the sample container during processing, even when exposed to extreme heat or chemicals like DMSO, Xylene and Ethanol, ensuring secure sample identification in the most challenging laboratory conditions.

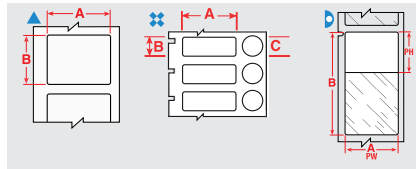

Labels are shown per vial / tube size and in order of label width.

The background colours in the Order Reference column represent the material colour.

Diagram	Material	Special Properties	Label Width A (mm)	Label Height B (mm)	Label Length B (m)	Diameter C (mm)	Printable Area Width PW (mm)	Printable Area Height PH (mm)	Order Reference	Printer Compatibility	Printer Ribbon Series	Labels per Roll
0.3 ml Straw												
▲	B-492	F N H L	25.40	25.40	-	-	-	-	M71-19-492	BMP71	M71-R6400	250
0.5 - 0.7 ml												
▲	B-499	F N A	12.70	19.05	-	-	12.70	19.05	M71-11-499	BMP71	M71-R4300	500
▲	B-492	F N H L	25.40	9.53	-	-	-	-	M71-16-492	BMP71	M71-R6400	500
⊗	B-499	F A	25.40	9.53	-	9.53	25.40	9.53	M71-98-499	BMP71	M71-R4300	500
0.6 ml												
▲	B-499	F N A	22.86	12.70	-	-	22.86	12.70	M71-84-499	BMP71	M71-R4300	500
1.0 - 2.0 ml												
⊗	B-492	F H L	25.40	12.70	-	9.53	-	-	M71-118-492	BMP71	M71-R6400	500
1.0 - 8.0 ml												
▲	B-490	F N H L	41.28	15.24	-	-	-	-	M71-76-490	BMP71	M71-R4300	500
▲	B-492	F N H L	48.26	25.40	-	-	-	-	M71-78-492	BMP71	M71-R6400	250
▢	B-461	F N A H S L	66.68	25.40	-	-	25.40	25.40	BM71-75-461	M611, BMP61, BMP71	R6200	1000
12.0 - 24.0 ml												
▲	B-498	F R	12.70	38.10	-	-	12.70	38.10	BM71-29-498	M611, BMP61, BMP71	R6200	5000
▲	B-499	F N A	12.70	38.10	-	-	12.70	38.10	M71-29-499	BMP71	M71-R4300	500
▲	B-498	F R	38.10	12.70	-	-	38.10	12.70	M71-29-498	BMP71	M71-R6200	500
50.0 ml												
▲	B-492	F N H L	25.40	12.70	-	-	-	-	M71-17-492	BMP71	M71-R6400	500

Order references beginning with "B" indicate bulk rolls.



Tissue cassette labels

- Tissue cassettes are often re-identified when labs collect samples from various biorepositories. Typically, each laboratory has its own unique way of identifying samples, which creates a need to re-identify samples in a common way.
- Brady B-498 post-process labels offer customers the optimal way to organise these specimens and conduct further studies. These labels can be applied directly onto the cassettes, on pure paraffin wax and on top of another label or identifier.

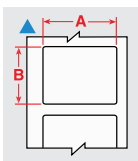

Diagram	Material	Special Properties	Label Width A (mm)	Label Height B (mm)	Order Reference	Printer Compatibility	Printer Ribbon Series	Labels per Roll
▲	B-498	F R	6.35	19.05	M71-10-498	BMP71	M71-R6200	750
▲	B-498	F R	12.70	12.70	M71-7-498	BMP71	M71-R6200	500
▲	B-498	F R	12.70	19.05	BM71-11-498	M611, BMP61, BMP71	R6200	5000
▲	B-498	F R	12.70	19.05	M71-11-498	BMP71	M71-R6200	500
▲	B-498	F R	19.05	25.40	BM71-18-498	M611, BMP61, BMP71	R6200	2500
▲	B-498	F R	19.05	25.40	M71-18-498	BMP71	M71-R6200	250
▲	B-498	F R	25.40	12.70	M71-17-498	BMP71	M71-R6200	500

Order references beginning with "B" indicate bulk rolls.

F Freezer environment N Liquid nitrogen environment A Autoclave environment H Hot water bath (100°C) S Self-laminating label L Low-profile (extremely thin) label R Removable

Specimen storage identification

Well plate labels

When total tracking of all sample collections is required then Brady has a solution for Well plate identification. Our well plate labels guarantee crystal clear text and barcoding for most lab environments.

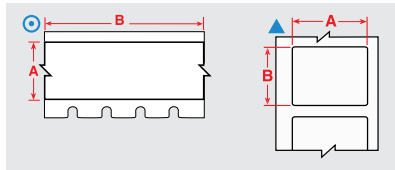

Labels are shown in order of label width.

The background colours in the Order Reference column represent the material colour.

Diagram	Material	Special Properties	Label Width A (mm)	Label Height B (mm)	Label Length B (m)	Order Reference	Printer Compatibility	Printer Ribbon Series	Labels per Roll
⊙	B-498		6.10	-	9.14	M71C-240-498	BMP71	M71-R6200	1
⊙	B-498		6.10	-	83.80	BM71C-240-498	M611, BMP61, BMP71	R6200	1
▲	B-498	F R	6.35	19.05	-	M71-10-498	BMP71	M71-R6200	750
⊙	B-498		8.08	-	9.14	M71C-318-498	BMP71	M71-R6200	1
⊙	B-498		8.08	-	83.80	BM71C-318-498	M611, BMP61, BMP71	R6200	1
⊙	B-498		9.53	-	9.14	M71C-375-498	BMP71	M71-R6200	1
⊙	B-498		9.53	-	83.80	BM71C-375-498	M611, BMP61, BMP71	R6200	1
⊙	B-498	F R	12.70	-	9.10	M71C-500-498	BMP71	M71-R6200	1
⊙	B-595	F	12.70	-	15.24	M71C-500-595-BK	BMP71	M71-R4400-WT	1
⊙	B-595	F	12.70	-	15.24	M71C-500-595-BL	BMP71	M71-R4400-WT	1
⊙	B-595		12.70	-	15.24	M71C-500-595-BR	BMP71	M71-R4400-WT	1
⊙	B-595	F	12.70	-	15.24	M71C-500-595-CL	BMP71	M71-R6000HF	1
⊙	B-595		12.70	-	15.24	M71C-500-595-GD	BMP71	M71-R6000HF	1
⊙	B-595	F	12.70	-	15.24	M71C-500-595-GN	BMP71	M71-R4400-WT	1
⊙	B-595		12.70	-	15.24	M71C-500-595-GY	BMP71	M71-R6000HF	1
⊙	B-595		12.70	-	15.24	M71C-500-595-LB	BMP71	M71-R4400-WT	1
⊙	B-595		12.70	-	15.24	M71C-500-595-OC	BMP71	M71-R6000HF	1
⊙	B-595	F	12.70	-	15.24	M71C-500-595-OR	BMP71	M71-R6000HF	1
⊙	B-595		12.70	-	15.24	M71C-500-595-PK	BMP71	M71-R6000HF	1
⊙	B-595		12.70	-	15.24	M71C-500-595-PL	BMP71	M71-R4400-WT	1
⊙	B-595	F	12.70	-	15.24	M71C-500-595-RD	BMP71	M71-R4400-WT	1
⊙	B-595		12.70	-	15.24	M71C-500-595-SB	BMP71	M71-R4400-WT	1
⊙	B-595		12.70	-	15.24	M71C-500-595-TN	BMP71	M71-R6000HF	1
⊙	B-595	F	12.70	-	15.24	M71C-500-595-WT	BMP71	M71-R6000HF	1
⊙	B-595	F	12.70	-	15.24	M71C-500-595-YL	BMP71	M71-R6000HF	1
⊙	B-430	F A H	12.70	-	15.24	M71C-500-430	BMP71	M71-R6000HF	1
▲	B-423	F A H	12.70	12.70	-	BM71-7-423	M611, BMP61, BMP71	R6000HF	5000
▲	B-499		12.70	12.70	-	M71-7-499	BMP71	M71-R4300	500
▲	B-498		12.70	12.70	-	M71-7-498	BMP71	M71-R6200	500
▲	B-423	F A H	12.70	12.70	-	M71-7-423	BMP71	M71-R6000HF	500
▲	B-499	F N A	12.70	19.05	-	BM71-11-499	M611, BMP61, BMP71	R4300	5000
▲	B-498	F R	12.70	38.10	-	BM71-29-498	M611, BMP61, BMP71	R6200	5000
▲	B-499	F N A	12.70	38.10	-	M71-29-499	BMP71	M71-R4300	500
▲	B-499		15.00	9.00	-	M71-67-499-YL	BMP71	M71-R4300	750
▲	B-499		16.00	5.00	-	M71-41-499-YL	BMP71	M71-R4300	750
▲	B-498	F R	19.05	25.40	-	BM71-18-498	M611, BMP61, BMP71	R6200	2500
▲	B-499	F N A	19.05	25.40	-	M71-18-499	BMP71	M71-R4300	250
▲	B-498	F R	19.05	25.40	-	M71-18-498	BMP71	M71-R6200	250
▲	B-499	F N A	19.05	38.10	-	M71-30-499	BMP71	M71-R4300	250
▲	B-498		19.05	38.10	-	M71-30-498	BMP71	M71-R6200	250
⊙	B-499	F N A	25.40	-	9.10	M71C-1000-499	BMP71	M71-R4300	1
⊙	B-498		25.40	-	9.10	M71C-1000-498	BMP71	M71-R6200	1
⊙	B-595	F	25.40	-	15.24	M71C-1000-595-BK	BMP71	M71-R4400-WT	1
⊙	B-595	F	25.40	-	15.24	M71C-1000-595-BL	BMP71	M71-R4400-WT	1
⊙	B-595		25.40	-	15.24	M71C-1000-595-BR	BMP71	M71-R4400-WT	1
⊙	B-595	F	25.40	-	15.24	M71C-1000-595-CL	BMP71	M71-R6000HF	1
⊙	B-595		25.40	-	15.24	M71C-1000-595-GD	BMP71	M71-R6000HF	1

Order references beginning with "B" indicate bulk rolls.

>>

Specimen storage identification

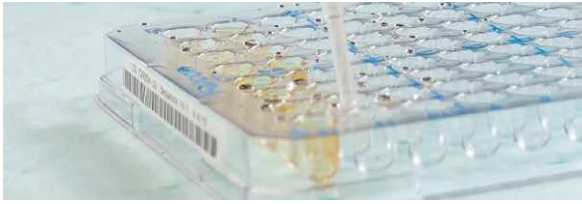

Well plate labels (Continued)

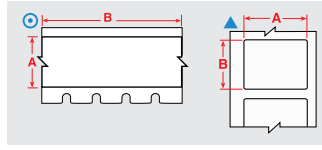

Labels are shown in order of label width.

The background colours in the Order Reference column represent the material colour.

Diagram	Material	Special Properties	Label Width A (mm)	Label Height B (mm)	Label Length B (m)	Order Reference	Printer Compatibility	Printer Ribbon Series	Labels per Roll
⊙	B-595	F	25.40	-	15.24	M71C-1000-595-GN	BMP71	M71-R4400-WT	1
⊙	B-595		25.40	-	15.24	M71C-1000-595-GY	BMP71	M71-R6000HF	1
⊙	B-595		25.40	-	15.24	M71C-1000-595-LB	BMP71	M71-R4400-WT	1
⊙	B-595		25.40	-	15.24	M71C-1000-595-OC	BMP71	M71-R6000HF	1
⊙	B-595	F	25.40	-	15.24	M71C-1000-595-OR	BMP71	M71-R6000HF	1
⊙	B-595		25.40	-	15.24	M71C-1000-595-PK	BMP71	M71-R6000HF	1
⊙	B-595		25.40	-	15.24	M71C-1000-595-PL	BMP71	M71-R4400-WT	1
⊙	B-595	F	25.40	-	15.24	M71C-1000-595-RD	BMP71	M71-R4400-WT	1
⊙	B-595		25.40	-	15.24	M71C-1000-595-SB	BMP71	M71-R4400-WT	1
⊙	B-595		25.40	-	15.24	M71C-1000-595-TN	BMP71	M71-R6000HF	1
⊙	B-595	F	25.40	-	15.24	M71C-1000-595-WT	BMP71	M71-R6000HF	1
⊙	B-595	F	25.40	-	15.24	M71C-1000-595-YL	BMP71	M71-R6000HF	1
▲	B-423	F A H	25.40	4.75	-	M71-14-423	BMP71	M71-R6000HF	750
▲	B-423	F A H	25.40	6.99	-	M71-15-423	BMP71	M71-R6000HF	750
▲	B-498	F R	25.40	12.70	-	M71-17-498	BMP71	M71-R6200	500
▲	B-430	F A H	25.40	12.70	-	M71-17-430	BMP71	M71-R6000HF	500
▲	B-423	F A H	25.40	12.70	-	M71-17-423	BMP71	M71-R6000HF	500
▲	B-498		25.40	25.40	-	BM71-19-498	M611, BMP61, BMP71	R6200	2500
▲	B-499	F N A	25.40	25.40	-	M71-19-499	BMP71	M71-R4300	250
▲	B-498		25.40	25.40	-	M71-19-498	BMP71	M71-R6200	250
▲	B-499	F N A	25.40	38.10	-	M71-31-499	BMP71	M71-R4300	250
▲	B-498	F R	25.40	38.10	-	M71-31-498	BMP71	M71-R6200	250
▲	B-423	F A H	25.40	50.80	-	M71-20-423	BMP71	M71-R6000HF	100
▲	B-499		38.10	6.35	-	M71-28-499	BMP71	M71-R4300	750
▲	B-498	F R	38.10	12.70	-	M71-29-498	BMP71	M71-R6200	500
▲	B-423	F A H	38.10	25.40	-	M71-31-423	BMP71	M71-R6000HF	250
▲	B-498		38.10	38.10	-	M71-32-498	BMP71	M71-R6200	250
⊙	B-499	F N A	48.26	-	9.10	M71C-1900-499	BMP71	M71-R4300	1
⊙	B-498		48.26	-	9.10	M71C-1900-498	BMP71	M71-R6200	1
▲	B-499	F N A	48.26	6.35	-	M71-81-499	BMP71	M71-R4300	750
▲	B-488	F A	48.26	6.35	-	M71-81-488	BMP71	M71-R4300	750
▲	B-499	F N A	48.26	25.40	-	M71-78-499	BMP71	M71-R4300	250
▲	B-423	F A H	50.80	6.35	-	M71-2-423	BMP71	M71-R6000HF	100
▲	B-423	F A H	66.38	50.80	-	BM71-20-423	M611, BMP61, BMP71	-	1000
▲	B-423	F A H	76.20	25.40	-	M71-22-423	BMP71	M71-R6000HF	100

Order references beginning with "B" indicate bulk rolls.

Bottle tamper seal labels

Brady's bottle seal identification provides tracking information with the added feature of security. These labelling materials are designed to fracture easily in order to show signs of sample tampering and to prevent one-piece label removal.



Diagram	Material	Special Properties	Label Width A (mm)	Label Height B (mm)	Order Reference	Printer Compatibility	Printer Ribbon Series	Labels per Roll
▲	B-351	F	25.40	12.70	M71-17-351	BMP71	M71-R6000HF	500
▲	B-351	F	25.40	50.80	M71-20-351	BMP71	M71-R6000HF	100
▲	B-351	F	38.10	25.40	M71-31-351	BMP71	M71-R6000HF	250
▲	B-351	F	76.20	48.26	M71-37-351	BMP71	M71-R6000HF	100

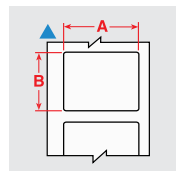

Lean lab identification



Water dissolvable labels

The B-403 water dissolvable paper label is self-adhesive and extremely easy to apply. Exposing the label to warm water will completely dissolve it within 30 seconds, without damage to the surface it was applied to, and without leaving any residue.

Diagram	Material	Special Properties	Label Width A (mm)	Label Length B (m)	Order Reference	Printer Compatibility	Printer Ribbon Series	Labels per Roll
⊙	B-403	R	19.05	15.25	M71C-750-403	BMP71	M61-R4300	1
⊙	B-403	R	38.10	15.25	M71C-1500-403	BMP71	M61-R4300	1

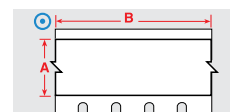

Bottles / flasks & dishes

Brady's labels for bottles, flasks and dishes are flexible, which makes them easy to apply to curved containers and remain attached and legible, even after being subjected to freezing, liquid nitrogen and heat.

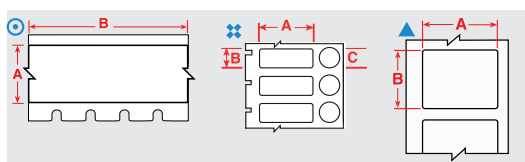

Labels are shown in order of label width.

The background colours in the Order Reference column represent the material colour.

Diagram	Material	Special Properties	Label Width A (mm)	Label Height B (mm)	Label Length B (m)	Diameter C (mm)	Order Reference	Printer Compatibility	Printer Ribbon Series	Labels per Roll
⊙	B-430	F A H	12.70	-	15.24	-	M71C-500-430	BMP71	M71-R6000HF	1
▲	B-423	F A H	12.70	12.70	-	-	BM71-7-423	M611, BMP61, BMP71	R6000HF	5000
▲	B-423	F A H	12.70	12.70	-	-	M71-7-423	BMP71	M71-R6000HF	500
▲	B-498	F R	12.70	38.10	-	-	BM71-29-498	M611, BMP61, BMP71	R6200	5000
▲	B-499	F N A	12.70	38.10	-	-	M71-29-499	BMP71	M71-R4300	500
▲	B-499	F N A	19.05	38.10	-	-	M71-30-499	BMP71	M71-R4300	250
▲	B-423	F A H	25.40	4.75	-	-	M71-14-423	BMP71	M71-R6000HF	750
▲	B-423	F A H	25.40	6.99	-	-	M71-15-423	BMP71	M71-R6000HF	750
▲	B-492	F N H L	25.40	9.53	-	-	M71-16-492	BMP71	M71-R6400	500
▲	B-498	F R	25.40	12.70	-	-	M71-17-498	BMP71	M71-R6200	500
▲	B-492	F N H L	25.40	12.70	-	-	M71-17-492	BMP71	M71-R6400	500
▲	B-430	F A H	25.40	12.70	-	-	M71-17-430	BMP71	M71-R6000HF	500
▲	B-423	F A H	25.40	12.70	-	-	M71-17-423	BMP71	M71-R6000HF	500
⊗	B-492	F H L	25.40	12.70	-	9.53	M71-118-492	BMP71	M71-R6400	500
▲	B-492	F N H L	25.40	25.40	-	-	M71-19-492	BMP71	M71-R6400	250
▲	B-423	F A H	25.40	50.80	-	-	M71-20-423	BMP71	M71-R6000HF	100
▲	B-498	F R	38.10	12.70	-	-	M71-29-498	BMP71	M71-R6200	500
▲	B-427	F N S	38.10	19.05	-	-	M71-30-427-AW	BMP71	M71-R4300	250
▲	B-490	F N H L	41.28	15.24	-	-	M71-76-490	BMP71	M71-R4300	500
▲	B-499	F N A	48.26	25.40	-	-	M71-78-499	BMP71	M71-R4300	250
▲	B-492	F N H L	48.26	25.40	-	-	M71-78-492	BMP71	M71-R6400	250
▲	B-423	F A H	66.38	50.80	-	-	BM71-20-423	M611, BMP61, BMP71	R6000HF	1000
▲	B-423	F A H	76.20	25.40	-	-	M71-22-423	BMP71	M71-R6000HF	100

Order references beginning with "B" indicate bulk rolls. *Order references ending with "AW" indicate all white labels with no clear area.

F Freezer environment N Liquid nitrogen environment A Autoclave environment H Hot water bath (100°C) S Self-laminating label L Low-profile (extremely thin) label R Removable

Lean lab identification



General lab equipment labels

With proper identification, time spent looking for the right sample or tool can be invested in what really matters. Brady offers a range of materials suitable for identifying drawers, cabinets, shelves, storage units and laboratory equipment.

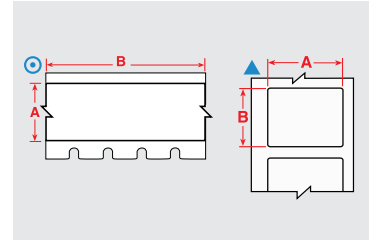

Diagram	Material	Special Properties	Label Width A (mm)	Label Height B (mm)	Label Length B (m)	Order Reference	Printer Compatibility	Printer Ribbon Series	Labels per Roll
⊙	B-430	F A H	9.53	-	15.24	M71C-375-430	BMP71	M71-R6000HF	1
▲	B-423		9.53	9.53	-	M71-3-423	BMP71	M71-R6000HF	500
▲	B-423		10.16	10.16	-	M71-4-423	BMP71	M71-R6000HF	500
⊙	B-595	F	12.70	-	15.24	M71C-500-595-BK	BMP71	M71-R4400-WT	1
⊙	B-595	F	12.70	-	15.24	M71C-500-595-BL	BMP71	M71-R4400-WT	1
⊙	B-595	F	12.70	-	15.24	M71C-500-595-CL	BMP71	M71-R6000HF	1
⊙	B-595	F	12.70	-	15.24	M71C-500-595-GN	BMP71	M71-R4400-WT	1
⊙	B-595	F	12.70	-	15.24	M71C-500-595-OR	BMP71	M71-R6000HF	1
⊙	B-595	F	12.70	-	15.24	M71C-500-595-RD	BMP71	M71-R4400-WT	1
⊙	B-595	F	12.70	-	15.24	M71C-500-595-WT	BMP71	M71-R6000HF	1
⊙	B-595	F	12.70	-	15.24	M71C-500-595-YL	BMP71	M71-R6000HF	1
⊙	B-430	F A H	12.70	-	15.24	M71C-500-430	BMP71	M71-R6000HF	1
⊙	B-423		12.70	-	15.24	M71C-500-423	BMP71	M71-R6000HF	1
▲	B-423	F A H	12.70	12.70	-	BM71-7-423	M611, BMP61, BMP71	R6000HF	5000
▲	B-423	F A H	12.70	12.70	-	M71-7-423	BMP71	M71-R6000HF	500
⊙	B-595	F	25.40	-	15.24	M71C-1000-595-BK	BMP71	M71-R4400-WT	1
⊙	B-595	F	25.40	-	15.24	M71C-1000-595-BL	BMP71	M71-R4400-WT	1
⊙	B-595	F	25.40	-	15.24	M71C-1000-595-CL	BMP71	M71-R6000HF	1
⊙	B-595	F	25.40	-	15.24	M71C-1000-595-GN	BMP71	M71-R4400-WT	1
⊙	B-595	F	25.40	-	15.24	M71C-1000-595-OR	BMP71	M71-R6000HF	1
⊙	B-595	F	25.40	-	15.24	M71C-1000-595-RD	BMP71	M71-R4400-WT	1
⊙	B-595	F	25.40	-	15.24	M71C-1000-595-WT	BMP71	M71-R6000HF	1
⊙	B-595	F	25.40	-	15.24	M71C-1000-595-YL	BMP71	M71-R6000HF	1
⊙	B-430	F A H	25.40	-	15.24	M71C-1000-430	BMP71	M71-R6000HF	1
▲	B-423		25.40	9.53	-	BM71-16-423	M611, BMP61, BMP71	R6000HF	5000
▲	B-430		25.40	9.53	-	M71-16-430	BMP71	M71-R6000HF	500
▲	B-423		25.40	9.53	-	M71-16-423	BMP71	M71-R6000HF	500
▲	B-423		25.40	12.70	-	BM71-17-423	M611, BMP61, BMP71	R6000HF	5000
▲	B-430	F A H	25.40	12.70	-	M71-17-430	BMP71	M71-R6000HF	500
▲	B-423	F A H	25.40	12.70	-	M71-17-423	BMP71	M71-R6000HF	500
▲	B-423		25.40	25.40	-	BM71-19-423	M611, BMP61, BMP71	R6000HF	2500
▲	B-423		25.40	25.40	-	M71-19-423	BMP71	M71-R6000HF	250
▲	B-424	F	25.40	50.80	-	BM71-20-424	M611, BMP61, BMP71	R4300	1000
▲	B-424	F	25.40	50.80	-	M71-20-424	BMP71	M71-R4300	100
▲	B-423	F A H	25.40	50.80	-	M71-20-423	BMP71	M71-R6000HF	100
▲	B-430		38.10	9.53	-	M71-45-430	BMP71	M71-R6000HF	500
▲	B-423		38.10	12.70	-	BM71-29-423	M611, BMP61, BMP71	R6000HF	5000
▲	B-423		38.10	12.70	-	M71-29-423	BMP71	M71-R6000HF	500
▲	B-423	F A H	38.10	25.40	-	M71-31-423	BMP71	M71-R6000HF	250
▲	B-423		38.10	38.10	-	M71-32-423	BMP71	M71-R6000HF	250
⊙	B-430	F A H	48.26	-	15.24	M71C-1900-430	BMP71	M71-R6000HF	1
⊙	B-595		50.80	-	15.24	M71C-2000-595-BK	BMP71	M71-R4400-WT	1
⊙	B-595		50.80	-	15.24	M71C-2000-595-BL	BMP71	M71-R4400-WT	1
⊙	B-595		50.80	-	15.24	M71C-2000-595-CL	BMP71	M71-R6000HF	1
⊙	B-595		50.80	-	15.24	M71C-2000-595-GN	BMP71	M71-R4400-WT	1
⊙	B-595		50.80	-	15.24	M71C-2000-595-OR	BMP71	M71-R6000HF	1
⊙	B-595		50.80	-	15.24	M71C-2000-595-RD	BMP71	M71-R4400-WT	1
⊙	B-595		50.80	-	15.24	M71C-2000-595-WT	BMP71	M71-R6000HF	1
⊙	B-595		50.80	-	15.24	M71C-2000-595-YL	BMP71	M71-R6000HF	1
▲	B-423	F A H	66.38	50.80	-	BM71-20-423	M611, BMP61, BMP71	R6000HF	1000

F Freezer environment N Liquid nitrogen environment A Autoclave environment H Hot water bath (100°C) S Self-laminating label L Low-profile (extremely thin) label R Removable

This section provides a quick reference to Brady materials listed throughout this brochure, including applications and regulatory compliance where applicable. For more detailed material attribute and performance information, please refer to the material's Technical Data Sheet, listed at www.bradyeurope.com/tds.

Material	Finish	Colour	Temp (°C) (Tested for 30 days)		Properties & Applications	Approval/Compliance	
			Min.	Max.			
B-109	Polyethylene Tag	Matt	White	-40 °C	49 °C	White polyethylene tag material with matt finish. Excellent multi-purpose tag for identifying multiconductor cables, inventory, safety warning repair and work-in-processing manufacturing. Good weatherability, humidity resistance and legibility after solvent exposure.	–
B-145	Polyethylene Tag	Matt	Grey	-40 °C	100 °C	This multipurpose material can be used for a variety of tag applications including identification of multiconductor cables, equipment, safety warning repair and work in progress.	–
B-342	Heat-shrink Polyolefin Sleeve	Matt	White	-55 °C	130.6 °C	3:1 ratio heat shrinkable wire marking sleeve that fits snugly around wires for identification and protection. Fade-resistant and flame retardant. Also available in yellow and black.	UL Recognised to UL224; SAE-AMS-DTL-23053/5 C (Class 1); SAE-AS-81531
B-348	Polyolefin	Matt	White	-55 °C	135 °C	Mass Transit Tag complies with minimal smoke and halogen emission requirements of the most strict underground norms for mass transit vehicles. The tag is a practical solution for mass transit manufacturers to identify thick cables and cable bundles.	–
B-351	Tamper-resistant Vinyl	Matt	White	-40 °C	80 °C	White vinyl material with matt finish. Tamper evident material fractures to show signs of product tampering and prevent one-piece removal.	–
B-362	Tamper-resistant Metallised Vinyl	Gloss	Silver	-70 °C	80 °C	Designed to fracture easily in order to show signs of product tampering and to prevent one-piece label removal. Use caution when removing from liner as material is fragile.	–
B-403	Paper	Matt	White	-70 °C	100 °C	White dissolvable paper. Dissolves completely in water leaving no adhesive residue, ideal for temporary labelling applications	–
B-412	Polypropylene Tag	Matt	White	-40 °C	100 °C	White polypropylene tag material with matt finish. Offers high print legibility and high tensile strength.	–
B-414	Polyester	Matt	White	-40 °C	50 °C	Get a grip on your wire and cable identification – Brady and VELCRO® Brand have partnered to bring you BradyGrip™ Print-on Hook Material, an exclusive print-and-place material that can be easily applied, repositioned or removed.	–
B-422	Polyester	Gloss	White	-40 °C	100 °C	Designed to withstand solvent exposure. Used for component identification, barcoding, asset and inventory tracking.	UL Recognised; CSA Accepted
B-423	Polyester	Gloss	White	-70 °C	110 °C	Widely used for component identification, barcoding, asset and inventory tracking.	UL Recognised; CSA Accepted; AGA Approved; Halogen Free (DIN VDE 0472/part 815)
B-424	Paper	Matt	White	-40 °C	50 °C	White paper material with matt finish and smooth top coat finish for thermal transfer printing. Good contrast and smear resistance for thermal barcode printing. Used for general purpose labeling applications	–
B-425A	Polypropylene	Matt	White	-70 °C	80 °C	White polypropylene material stock with matt finish for thermal transfer printing or write-on applications. Excellent solvent resistance and print performance; not recommended for long-term outdoor use.	UL Recognised; CSA Accepted; Halogen Free (DIN VDE 0472/part 815)
B-427	Self-laminating Vinyl	Matt	White, Transparent	-40 °C	60 °C	Thermal transfer printable, self-laminating material. These labels have a printable area with a clear "tail" that wraps around the marker. The "tail" serves as overlaminates to protect the print. Superior resistance to abrasion, solvents, water, oil and dirt. Also available in grey, brown, green, yellow, blue, red, purple, orange.	UL Recognised to UL969 Labelling and Marking Standard when printed with the Brady Series R4300 and R6200 ribbons. See UL files MH17154 for specific details. Brady customers should specify at purchase if they require UL Recognised B-427 labels. Brady sells both UL Recognised B-427 labels and non-approved labels depending on customer requirements.
B-428	Metallised Polyester	Matt	Light Grey	-70 °C	120 °C	Thermal transfer printable metallised polyester with matt finish. Withstands solvents and variable temperatures. Excellent for serial and rating plate applications with name-plate quality and a metal-looking finish.	UL Recognised; CSA Accepted; Halogen Free (DIN VDE 0472/part 815)
B-430	Polyester	Gloss	Transparent	-70 °C	100 °C	Translucent, high performance polyester material with a glossy finish. Thermal transfer printable.	UL Recognised; CSA Accepted
B-437	Polyvinylfluoride	Matt	White	-70 °C	135 °C	Polyvinylfluoride label material with matt finish. Used in wire and cable identification applications where self-extinguishing features are required. This label material utilises an adhesive for heavy-duty applications and is available in continuous or die-cut formats. Excellent resistance to water, oil and other common fluids. Also available in yellow.	MIL-M-87958 Pressure Sensitive Adhesive Wire or Cable Marker and Identification specification

Master material index

Material	Finish	Colour	Temp (°C) (Tested for 30 days)		Properties & Applications	Approval/Compliance	
			Min.	Max.			
B-459	Polyester	Matt	White	-40 °C	100 °C	White polyester thermal transfer printable material with matt finish. Designed for applications such as topside of printed circuit boards and rating plates that utilise high quality/ density alphanumerics, barcodes and graphics.	UL Recognised; CSA Accepted
B-461	Self-laminating Polyester	Matt	White, Transparent	-196 °C	110 °C	Permanent adhesive; suitable for liquid nitrogen application if material is wrapped around itself, as in self-lamination; write-on capabilities. Temperature range increases to 121°C when used in autoclave process	–
B-472	Polyimide	Matt	White	-70 °C	100 °C	Cable and wire bundle applications and label applications where self-extinguishing properties are required	–
B-473	Static Dissipative Polyester	Gloss	White	-40 °C	120 °C	This material is constructed with a static dissipative adhesive, it is designed for printed circuit board and electronic component post-process labeling.	UL Recognised; CSA Accepted; Meets surface resistivity values in the recommended range for dissipative ESD packaging materials as defined by ANSI/ESD S541-2008 (between 10 ⁴ and 10 ¹¹ ohms)
B-481	StainerBondz™ Polyester	Matt	White	-80 °C	130 °C	White polyester will remain resistant when exposed to xylene and other chemicals that are commonly used in the slide staining process	–
B-483A	Polyester	Gloss	White	-40 °C	120 °C	White polyester thermal transfer printable material with glossy finish and aggressive adhesive specifically designed for powder coated surfaces.	UL Recognised; CSA Accepted
B-483A / B-634	Polyester with Polyester Overlamine	Gloss	White	-18 °C	54 °C	ToughStripe™ floor marking thermal transfer printable polyester with ultra-aggressive adhesive which allows for printable messages to be placed on the floor. The floor marking roll ships with a separate roll of B-634 Polyester Overlamine to protect your legend. Ideal to create custom-printed floor labels. Available in white, yellow, red, orange, green, blue and black.	–
B-486B	Metallized Polyester	Matt	Light Grey	-40 °C	120 °C	Metallized polyester thermal transfer printable material, ideal for indoor product labeling, asset tracking and general ID on very rough surfaces.	UL Recognised; CSA Accepted
B-488	Polyester	Matt	White	-40 °C	145 °C	White polyester thermal transfer printable material, similar to B-423, but with matt finish. Widely used for component identification, barcoding, asset and inventory tracking.	UL Recognised; CSA Accepted
B-489A	Polyester	Matt	White	-40 °C	120 °C	White polyester thermal transfer printable material, similar to B-483, but with matt finish. Aggressive adhesive specifically designed for powder coated surfaces.	UL Recognised; CSA Accepted
B-490	Freezerbondz™ Polyester	Matt	White	-196 °C	130 °C	Can be applied to frozen surfaces including glass and polypropylene stored in liquid nitrogen, except for Vial Tops. Material must slightly overlap itself.	–
B-492	Freezerbondz™ Polyester	Matt	White	-196 °C	110 °C	Ultra thin; can label frosted/frozen (with overlap) or room temperature labels and lasts in liquid nitrogen and hot water baths	–
B-498	Vinyl Cloth	Semi-gloss	White	-40 °C	80 °C	White vinyl cloth label material with glossy finish. The adhesive and cloth backing give excellent holding power, while being repositionable and removing cleanly.	UL Recognised
B-499	Nylon Cloth	Matt	Black on White	-40 °C	90 °C	Nylon cloth material with matt finish. The adhesive allows labelling in environments with heat, cold, oil and dirt. Also available in yellow.	UL Recognised; CSA Accepted; Halogen Free (DIN VDE 0472/ part 815) Approvals are for White material only
B-529	Polypropylene	Gloss	White	-40 °C	100 °C	Brady's economy polypropylene tape is for use indoors on smooth, flat surfaces.	–
B-530	Tamper-resistant Vinyl	Gloss	White	-40 °C	90 °C	Brady's tamper resistant tape destructs into tiny fragments when tampered with.	–
B-582	Phosphorescent Polyester	Gloss	Photolum.	-40 °C	80 °C	Phosphorescent Polyester is used for exit and directional signs, identification of fire alarms and extinguishers, low location egress pathway markings, and directional systems for escape or evacuations routes.	ASTM E-2072-00 / ASTM E-2073-00; ASTM E-162; ASTM E-648; ASTM E-662; IMO Resolution A.752(18); ISO/GD 15370; Marine Safety Committee MSC.27(61); DIN 67510 (Parts 1 - 4) Meets OSHA 1910.37
B-584	Reflective Tape	Gloss	Orange	-40 °C	70 °C	Suitable for outdoor use. Also available in silver and yellow.	–
B-595	Vinyl	Gloss	White	-40 °C	82 °C	Durable, low-shrink vinyl with our most aggressive adhesive. Conforms to irregular, curved, rough and highly textured surfaces (painted cinder blocks, uneven wood, textured plastics, paper-jacketed pipes, powder-coated surfaces). Adheres to "difficult" low-surface energy items (PVC piping, blow-moulded equipment cases, ABS plastics, recycled plastics). Available in a wide range of colours.	BS5609:1986 Section 2 and section 3

Material	Finish	Colour	Temp (°C) (Tested for 30 days)		Properties & Applications	Approval/Compliance	
			Min.	Max.			
B-642	Polyvinylfluoride	Matt	White, Transparent	-70 °C	120 °C	Applications requiring self-extinguishing identification. Self-laminating, wire, cable and laboratory vial marking. Excellent abrasion and smudge resistance.	–
B-717	Polyimide	Gloss	White	-70 °C	300 °C	White polyimide material with glossy finish and ultra-durable adhesive. Used in printed circuit board and electronic component pre-process labelling. Designed for use with extreme wash protocol and cleaning chemicals. Surface resistivity values in the recommended range for dissipative ESD packing materials.	UL Recognised; Meets the requirements of ANSI/ESD S541-2008 (between 10 ⁴ and 10 ¹¹ ohms) for dissipative ESD packaging materials; Meets the performance requirements of MIL-STD-202G, Method 215K
B-718	Polyimide	Gloss	White	-70 °C	300 °C	White polyimide material, low profile (1 mil thickness), with glossy finish and ultra-durable adhesive. Used in printed circuit board and electronic component pre-process labelling. Designed for use with extreme wash protocol and cleaning chemicals. Surface resistivity values in the recommended range for dissipative ESD packing materials.	UL Recognised; Meets the requirements of ANSI/ESD S541-2008 (between 10 ⁴ and 10 ¹¹ ohms) for dissipative ESD packaging materials; Meets the performance requirements of MIL-STD-202G, Method 215K
B-719	Polyimide	Matt	White	-70 °C	300 °C	White polyimide material with matt finish and ultra-durable adhesive. Used in printed circuit board and electronic component pre-process labelling. Designed for use with extreme wash protocol and cleaning chemicals. Surface resistivity values in the recommended range for dissipative ESD packing materials.	UL Recognised; Meets the requirements of ANSI/ESD S541-2008 (between 10 ⁴ and 10 ¹¹ ohms) for dissipative ESD packaging materials; Meets the performance requirements of MIL-STD-202G, Method 215K
B-724	Polyimide	Matt	Amber	-70 °C	300 °C	Amber polyimide material with matt finish and ultra-durable adhesive. Used in printed circuit board and electronic component pre-process labelling. Designed for use with extreme wash protocol and cleaning chemicals.	Meets the performance requirements of MIL -STD-202G, Notice 12, Method 215K; Meets the requirements of SAE AS81531 Marking of Electrical Insulating Material
B-727	Polyimide	Gloss	White	-70 °C	300 °C	White polyimide material with glossy finish and ultra-durable adhesive. Used in printed circuit board and electronic component pre-process labelling. Designed for use with extreme wash protocol and cleaning chemicals.	UL Recognised; Meets the performance requirements of MIL -STD-202G, Notice 12, Method 215K; Dibutyltin and Diocetyl tin free.
B-7593	Polyethylene Foam Laminate Polyester	Gloss	White, Yellow, Red, Green, Silver, Black	-40 °C	100 °C	EPREP (Engraved Panel REPlacement labels) are designed for patch panel identification in identifying external push-buttons, switches and internal connection points. Also available in black, green, red, silver and yellow.	–
B-7598	Polyester Tag	Gloss	White, Yellow, Red, Green, Silver, Black, Blue	-40 °C	100 °C	A general identification polyester tag for cables exposed to extreme conditions. Up to 10 years outdoor durability. Also available in black, blue, green, red, silver and yellow.	Parts supplied in White, Black or Silver are Halogen Free as per IEC 61249-2-21 (2003-11)
B-7599	Polyethylene Tag	Matt	Yellow	-40 °C	50 °C	White polyethylene tag material. Rapido™ Wiremarking Sleeves are fast and easy to apply. Simply squeeze the edges of the material together, thread your wire through the holes and pull away the wire to release the marker.	–
B-7641	Heat-shrink Polyolefin Sleeve	Matt	White	-55 °C	105 °C	2:1 ratio heat shrinkable, zero halogen wire marking sleeves. The wire marking sleeves offer outstanding fire safety properties and minimal smoke emission. Also available in yellow.	BS-6853 (1999) Vehicle Category 1A; EN-45545-2, requirement 24, Vehicle Category HL3; Zero Halogen
B-7643	Thermoplastic Polyether Polyurethane	Matt	White, Yellow	-40 °C	90 °C	Thermal transfer and dot matrix printable wire and cable bundle tag for harsh environments. Low halogen material. Also available in black, orange, red and yellow.	Halogen free per IEC 61249-2-21 (2003-11), Adherence: SAE-AS81531-1998, Flame retardant: MIL-STD-202G
B-7696	Vinyl Tag	Gloss	White, Yellow	-40 °C	70 °C	Brady DuraSleeve® printable inserts create a durable legend. The rigid construction of the DuraSleeve wire marking system provides inserts that can easily be inserted into a clean carrier. The legend can be changed before or after termination. Also available in yellow.	UL94 V0
B-7697	Polyester	Matt	White	-40 °C	120 °C	Brady DuraSleeve® printable polyester wire marking inserts. The rigid construction of the DuraSleeve system provides inserts that can easily be inserted into a clean carrier.	–
B-854	Metal Detectable Polyester	Matt	White	-40 °C	110 °C	Tough against harsh washdown environments; metal detectable. Also available in yellow.	–
B-855	Polyester	Matt	White	-40 °C	110 °C	Tough against harsh washdown environments. Also available in yellow.	–

Design any label with Brady Workstation apps



Brady Workstation offers professional, intuitive apps to design quality product and cable labels and safety signs. Label design becomes easier, faster and quickly adaptable to new label norms thanks to centralised updates.

Select the apps you need

Simply select the apps you need, download the 30-day trial and purchase when satisfied.



Brady Workstation Basic Design Software Suite

Get everyone in your facility up and running quickly on as many computers as you like with this free label creation software! You'll have basic design, formatting, graphics and simple barcode libraries to create labels like a pro!

The Basic Suite is included with every printer, all you need to do is download it.
Workstation.BradyID.com/Free



Brady Workstation Product and Wire Identification Software Suite

Quickly identify your products and wires with customised text or graphical labels, using serialised or imported data.

Workstation.BradyID.com/ProductandWire



Brady Workstation Safety and Facility Identification Software Suite

Keep your facility safe and compliant by creating custom signs, label and pipemarkers, adding visual safety guidance.

Workstation.BradyID.com/SafetyAndFacility



Brady Workstation Laboratory Identification Software Suite

Easily identify any sample with the most wanted laboratory sample label design apps in our Brady Workstation Lab suite.

Workstation.BradyID.com/lab



Try it today! Discover Brady Workstation at www.bradyeurope.com/workstation or download at workstation.bradyid.com.

PRINTER

Description	The BMP71 is your essential tool that handles all your labelling needs.
Includes	This printer kit ships in a hard case with Rechargeable NiMH Battery, AC Adaptor, USB Communications Cable, Media Adaptor, Quick Start Guide, Product CD (w/ Printer Driver, Tutorials, Full User's Guide), Cleaning Kit, a Brady Workstation Suite, M71C-2000-595-WT, M71-31-423 and M71-R6000
Applications	Electrical labelling Facility identification Laboratory labelling Wire and cable labelling
Print Speed (mm/sec)	38.00 mm/s
Internal Memory Capacity	200 MB -up to 100,000 labels
Cutter	Single Hand Manual Actuate Straight Cut Between labels or at end of print job
Keyboard Type	QWERTY, QWERTZ, AZERTY, CYRILLIC
Colour Capability	Monocolour
Language Support	Bulgarian, Czech, Danish, Dutch, English, Finnish, French, German, Hungarian, Italian, Norwegian (Bokmål), Polish, Portuguese, Romanian, Russian, Slovak, Slovenian, Spanish, Swedish
Weight (kg)	2.49
Width x Height x Depth (mm)	241.30 x 332.70 x 116.80
Operating Temperature	5°C - 49°C
Operating Humidity	10%-90% (non-condensing)
Storage Temperature	-40° - 70° C
Warranty	2 years

MEDIA SUPPORTED

Materials Supported	Over 400 Stock Parts, Continuous, Die Cut and Bulk Label Rolls
Continuous vs Die-cut Labels	Continuous and Die-cut
Custom Labels	Yes
Smart Cell	Yes
Max. Label Width (mm)	50.80
Min. Label Width (mm)	6.35 mm
Max. Liner Width (mm)	57.00
Recommended Usage per Day	1000

POWER SUPPLY

Battery Type	Rechargeable NiMH Battery
Power Supply	AC Adaptor Rechargeable Battery

DISPLAY

Display	Colour LCD Screen
Display Resolution	320 x 240 px

FONTS/GRAPHICS/SYMBOLOLOGIES

Text Sizes (pt)	4 - 174 pt
Built-in Fonts	Arial Alternative Monospaced Swiss 721
Built-in Symbols	500+
Bar Code Capability	Yes
Bar Code Type	Code 39;128; more through software

PRINTING FUNCTIONS

Serialisation	Simple & Simultaneous & Single Advanced & Multiple Advanced
Print Resolution (dpi)	300 dpi

SOFTWARE & CONNECTIVITY

Connectivity Options	USB
Software Compatibility	Brady Workstation



BMP71 Printer, kits and accessories

Printers



► For more information about the Brady Workstation Software Suites, see page 52. The Basic Suite is included with every printer, all you need to do is download it. Workstation.BradyID.com/Free

Order Reference	Art. No.	Description
BMP71-AZERTY-EU	710601	BMP71 Label Printer - AZERTY
BMP71-AZ-EU-LABS	306861	BMP71 Label Printer - AZERTY with Brady Workstation LAB Suite
BMP71-AZ-EU-PWID	198643	BMP71 Label Printer - AZERTY with Brady Workstation PWID Suite
BMP71-AZ-EU-SFIDS	198679	BMP71 Label Printer - AZERTY with Brady Workstation SFID suite
BMP71-CYRILLIC-EU	710604	BMP71 Label Printer - CYRILLIC
BMP71-CYR-LABS	306865	BMP71 Label Printer - CYRILLIC with Brady Workstation LAB Suite
BMP71-CYR-PWID	198644	BMP71 Label Printer - CYRILLIC with Brady Workstation PWID Suite
BMP71-CYR-SFIDS	198680	BMP71 Label Printer - CYRILLIC with Brady Workstation SFID suite
BMP71-QWERTY-EU	710599	BMP71 Label Printer - QWERTY EU
BMP71-QY-EU-LABS	306862	BMP71 Label Printer - QWERTY EU with Brady Workstation LAB Suite
BMP71-QY-EU-PWID	198645	BMP71 Label Printer - QWERTY EU with Brady Workstation PWID Suite
BMP71-QY-EU-SFIDS	198681	BMP71 Label Printer - QWERTY EU with Brady Workstation SFID suite
BMP71-QWERTY-UK	710600	BMP71 Label Printer - QWERTY UK
BMP71-QY-UK-LABS	306864	BMP71 Label Printer - QWERTY UK with Brady Workstation LAB Suite
BMP71-QY-UK-PWID	198646	BMP71 Label Printer - QWERTY UK with Brady Workstation PWID Suite
BMP71-QY-UK-SFIDS	198682	BMP71 Label Printer - QWERTY UK with Brady Workstation SFID suite
BMP71-US	115157	BMP71 Label Printer - QWERTY US
BMP71-QWERTZ-EU	710603	BMP71 Label Printer - QWERTZ
BMP71-QZ-EU-LABS	306863	BMP71 Label Printer - QWERTZ with Brady Workstation LAB Suite
BMP71-QZ-EU-PWID	198647	BMP71 Label Printer - QWERTZ with Brady Workstation PWID Suite
BMP71-QZ-EU-SFIDS	198683	BMP71 Label Printer - QWERTZ with Brady Workstation SFID suite

All printer kits ship in a hard case with Rechargeable NiMH Battery, AC Adaptor, USB Communications Cable, TLS2200/HandiMark Material Roll Adaptor, Quick Start Guide, Product CD (w/ Printer Driver, Tutorials, Full User's Guide), Cleaning Kit, M71C-2000-595-WT, M71-31-423, M71-R6000 and the Brady Workstation Basic Suite unless another BWS Suite is mentioned in the description.

Printer kits

BMP71 label printer kits created for the Electrical & Teledatcom industries. These interestingly priced portable printer kits come with a practical hard case, including a printer, label materials, a battery and accessories.



Order Reference	Art. No.	Description
BMP71-AZ-EU-ELEC*	198670	BMP71 Label Printer - Electrical Printer Kit - AZERTY
BMP71-CYR-ELEC*	198672	BMP71 Label Printer - Electrical Printer Kit - CYRILLIC
BMP71-QY-EU-ELEC*	198674	BMP71 Label Printer - Electrical Printer Kit - QWERTY - EU
BMP71-QY-UK-ELEC*	198676	BMP71 Label Printer - Electrical Printer Kit - QWERTY - UK
BMP71-QZ-EU-ELEC*	198678	BMP71 Label Printer - Electrical Printer Kit - QWERTZ
BMP71-AZ-EU-DATA**	198669	BMP71 Label Printer - Voice- and Datacom Kit - AZERTY
BMP71-CYR-DATA**	198671	BMP71 Label Printer - Voice- and Datacom Kit - CYRILLIC
BMP71-QY-EU-DATA**	198673	BMP71 Label Printer - Voice- and Datacom Kit - QWERTY - EU
BMP71-QY-UK-DATA**	198675	BMP71 Label Printer - Voice- and Datacom Kit - QWERTY - UK
BMP71-QZ-EU-DATA**	198677	BMP71 Label Printer - Voice- and Datacom Kit - QWERTZ

All printer kits ship in a hard case with a rechargeable NiMH battery, AC adaptor, USB communications cable, TLS2200/HandiMark material roll adaptor, quick start guide, product CD (w/ printer driver, tutorials, full user's guide), a cleaning kit and the Brady Workstation Product & Wire Identification Suite. Each kit comes with consumables aimed at the specific application.

Electrical kit: M71-19-427, M71C-2000-595-WT, M71-31-423, M71-R4300 and M71-R6000.

Voice- & Datacom kit: M71-21-427, M71C-2000-595-WT, M71-31-423, M71-R4300 and M71-R6000.

Consumable kits

Collections of tapes and or ribbons sold as a group to get you started with a specific application (no printer included).



Order Reference	Art. No.	Description	Includes
BMP71-FLOOR-KIT	301021	BMP71 Floormarking consumable kit	1x M71-R6000HF, 1x M71-2000-483-WT-KT, 1x M71-2000-483-YL-KT 1x M71-R6000HF, 1x M71-R4400-WT, 1x M71C-2000-595-BL,
BMP71-PIPE-KIT	301023	BMP71 Pipemarking consumable kit	1x M71C-2000-595-BR, 1x M71C-2000-595-GN, 1x M71C-2000-595-PL, 1x M71C-2000-595-RD, 1x M71C-2000-595-YL
BMP71-SAFETY-KIT	301022	BMP71 Safety consumable kit	1x M71-R6000HF, 1x M71-R6900-RD, 1x M71-R6900-BL, 1x M71-R6900-GN, 1x M71-R6900-MA, 1x M71-R6900-YL, 1x M71C-2000-595-WT, 1x M71C-2000-595-YL

Accessories



Soft carry case



Cleaning kit



Quick charger

Art. No.	Description
710612	AC Adaptor, Europe 220V
710613	AC Adaptor, UK 240V
114886	Cleaning Kit
114881	Hard sided Carry Case
147998	Media Adaptor for BMP71 Printer
150619	Protective softbag for portable printers - BMP71
710614	Quick Charger, Europe 220V
710615	Quick Charger, UK 240V
114884	Quick Charger, US 120V
114885	Rechargeable Nickel Metalhydride battery for the BMP71 printer
103788	USB Cable

2 year warranty on all Brady portable printers

Brady offers a 2 year warranty on every Brady Mobile Printer sold. This manufacturer's warranty is completely free and highlights Brady's commitment to quality and on-the-job reliability.

Flash this QR Code to access to all the details about the Brady warranty.



What if you want more extensive support ?

Brady offers Assist Base, Assist Field and Assist Custom service contracts which include priority assistance for 1, 3 or 5 years to guarantee continued support and the ultimate printer reliability, even in demanding working environments. These agreements also include many great extras versus our free, standard 2 year warranty, such as: spare parts, a solution within 2 business days, free annual preventive maintenance, repair transportation costs, priority access to the technical service team or even a specialist at your premises. Get all of these extra assurances for less than the cost of one flat fee repair!

Our training and setup service

- **Brady Setup Base** : Stress free installation of your Brady printer and software by screensharing. We help you produce your first labels.
- **Brady Setup Field** : Stress free installation of your Brady printer and software by a Brady specialist at your premises. We help you produce your first labels.
- **Brady Training Half/Whole day** : Hands-on training by a Brady specialist at your premises.



Please contact us for additional information!

Africa

Randburg, South Africa
 Tel.: +27 11 704 3295
 Email: africa@bradycorp.com

Benelux

Zele, Belgium
 Tel.: +32 (0) 52 45 78 11
 Email: benelux@bradycorp.com

Central & Eastern Europe

Bratislava, Slovakia
 Tel.: +421 2 3300 4800
 Email: central_europe@bradycorp.com

Denmark

Odense
 Tel.: +45 66 14 44 00
 Email: denmark@bradycorp.com

France

Roncq
 Tel.: +33 (0) 3 20 76 94 48
 Email: france@bradycorp.com

Germany, Austria & Switzerland

Egelsbach, Germany
 Tel.: +49 (0) 6103 7598 660
 Email: germany@bradycorp.com

Hungary

Budaörs
 Tel.: +36 23 500 275
 Email: central_europe@bradycorp.com

Italy

Gorgonzola
 Tel.: +39 02 26 00 00 22
 Email: italy@bradycorp.com

Middle East FZE

Dubai, UAE
 Tel.: +971 4881 2524
 Email: me@bradycorp.com

Norway

Kjeller
 Tel.: +47 70 13 40 00
 Email: norway@bradycorp.com

Russia

Moscow
 Tel.: +7 495 269 47 87
 Email: central_europe@bradycorp.com

Spain & Portugal

Madrid, Spain
 Tel.: +34 900 902 993
 Email: spain@bradycorp.com,
 portugal@bradycorp.com

Sweden, Finland, Baltic states

Kista, Sweden
 Tel.: +46 (0) 8 590 057 30
 Email: sweden@bradyeurope.com

Turkey

Istanbul
 Tel.: +90 212 264 02 20 / 264 02 21
 Email: turkey@bradycorp.com

UK & Ireland

Banbury, UK
 Tel.: +44 (0) 1295 228 288
 Email: uk@bradycorp.com

Our mission is to identify and protect people, products and premises



To help minimise our impact on the environment, Brady limits its number of reprints.

Updated versions are always available for download on www.bradyeurope.com.



Search for: EUR-M-710-EN



Y1165537

Twój dystrybutor marki Brady:



HTS-Polska Strzyga sp.j.
 Wola Pieczynska 27
 05-650 Chynów49
 NIP: 797 202 62

T: +48 22 619 07 70
 M: +48 505 612 159
 M: +48 501 753 716
 e-mail: info@hts-polska.pl

17/05/2021